

ALGIZ RT7

MANUAL



handheld

FEDERAL COMMUNICATIONS COMMISSION

This equipment has been tested and found to comply with the limits for a Class B digital device, pursuant to Part 15 of the FCC Rules. Operation is subject to the following two conditions: (1) this device may not cause interference, and (2) this device must accept any interference, including interference that may cause undesired operation of the device. IEEE 802.11b or 802.11g operation of this product is firmware-limited to channels 1 through 11.

These limits are designed to provide reasonable protection against harmful interference in a residential installation. This equipment generates, uses and can radiate radio frequency energy and, if not installed and used in accordance with the instructions, may cause harmful interference to radio communications. However, there is no guarantee that interference will not occur in a particular installation. If this equipment does cause harmful interference to radio or television reception, which can be determined by turning the equipment off and on, the user is encouraged to try to correct the interference by one or more of the following measures:

- Reorient or relocate the receiving antenna.
- Increase the separation between the equipment and receiver.
- Connect the equipment into an outlet on a circuit different from that to which the receiver is connected.
- Consult the dealer or an experienced radio/TV technician for help.

CAUTION: Any changes or modifications not expressly approved by the party responsible for compliance could void the user's authority to operate the equipment.

RF exposure warning

A separation distance of 10mm shall be maintained from the Human body in normal use.

RF exposure information (SAR)

This Rugged Tablet PC meets the government's requirements for exposure to radio waves. This Rugged Tablet PC is designed and manufactured not to exceed the emission limits for exposure to radio frequency (RF) energy set by the Federal Communications Commission of the U.S. Government. The exposure standard for wireless Rugged Tablet PC employs a unit of measurement known as the Specific Absorption Rate, or SAR. The SAR limit set by the FCC is 1.6W/kg. Tests for SAR are conducted using standard operating positions accepted by the FCC with the Rugged Tablet PC transmitting at its highest certified power level in all tested frequency bands. Although the SAR is determined at the highest certified power level, the actual SAR level of the Rugged Tablet PC while operating can be well below the maximum value. This is because the Rugged Tablet PC is designed to operate at multiple power levels so as to use only the power required to reach the network. In general, the closer you are to a wireless base station antenna, the lower the power output.

Industry Canada Class B Statement

This Class [B] digital apparatus complies with Canadian ICES-003. Cet appareil numérique de la classe [B] est conforme à la norme NMB-003 du Canada.

This device complies with Industry Canada license-exempt RSS standard(s). Operation is subject to the following two conditions: (1) this device may not cause interference, and (2) this device must accept any interference, including interference that may cause undesired operation of the device. IEEE 802.11b or 802.11g operation of this product in the Canada is firmware-limited to channels 1 through 11.

Déclarations d'exposition aux RF liées Avertissement d'exposition RF:

L'équipement est conforme aux limites d'exposition aux RF établies pour un environnement non contrôlé. L'antenne (s) utilisée pour ce transmetteur ne doit pas être Co-localisés ou fonctionnant en conjonction avec une autre antenne ou transmetteur. Ce dispositif est conforme à la norme de l'industrie Canada exempts de licence RSS (s). L'opération est soumise aux deux conditions suivantes: (1) Cet appareil ne peut causer d'interférences nuisibles, et (2) cet appareil doit accepter toute interférence reçue, y compris les interférences qui peuvent causer un mauvais fonctionnement de l'appareil.

CONTENTS

1. Introduction	6
2. Regulatory	7
2.1. Device Specification	8
2.1.1. Barcode Scanner.....	11
2.2. Accessories.....	12
2.3. Physical Layout.....	13
2.3.1. Bottom Panel.....	14
3. Device Setup	15
3.1. SIM Card Insertion	15
3.2. SD Card	16
3.3. Charging the device.....	16
4. Basic Usage Instructions.....	17
4.1. Power ON.....	17
4.2. Audio Volume.....	17
4.3. Initial Startup	18
4.4. Home Screen	18
4.4.1. Navigation Bar.....	19
4.5. Applications Screen	19
4.6. Lock Screen	20
4.7. Quick Settings.....	21
4.7.1. Adjusting Screen Brightness	21
4.7.2. Control Wi-Fi	21
4.7.3. Control Bluetooth	21
4.7.4. Invert Screen Colors.....	21
4.7.5. Airplane Mode	21
4.7.6. Screen Auto-Rotate.....	21
4.7.7. Location.....	21
4.8. Make a Phone Call/SMS	22
4.8.1. Pair a Bluetooth headset	22
4.9. Connect to a Network	22
4.10. Configure Google Account.....	22
4.11. Useful Applications	22
4.11.1. Install Applications	22
4.12. Configure Hotkeys	22
4.13. Notifications	22
4.14. Scanning Barcodes.....	22
4.15. Software Updates	22
4.16. Factory Reset.....	23
5. Settings	23
5.1. Wireless & network	23
5.1.1. WI-FI.....	24

5.1.2. Bluetooth	25
5.1.3. SIM cards	30
5.1.4. Ethernet	30
5.1.5. Network Selection Policy.....	33
5.2. Device	33
5.2.1. Display.....	34
5.2.2. Sound & notification	35
5.2.3. Storage.....	36
5.2.4. Battery	38
5.2.5. USB Host.....	38
5.2.6. Barcode.....	39
5.2.7. Apps	40
5.3. Personal.....	41
5.3.1. Location.....	41
5.3.2. Security	43
5.3.3. Accounts	43
5.3.4. Language & input	43
5.3.5. Backup & Reset.....	43
5.4. System	44
5.4.1. Date & time.....	44
5.4.2. Printing	44
5.4.3. Accessibility.....	45
5.4.4. About tablet.....	45
5.5. User Configurable Hotkeys	46
5.6. Applications	48
6. Storage.....	49
6.1. Internal Storage.....	49
6.2. SD card	49
6.3. USB Storage	49
7. Input	50
7.1. Touch Screen.....	50
7.2. USB Input devices	50
7.3. Bluetooth Input devices	50
8. Communication	51
8.1. Ethernet.....	51
8.2. Wireless Communication	52
8.2.1. Bluetooth	52
8.2.2. Wi-Fi.....	54
9. Location.....	55
9.1. Internal GPS.....	55
9.2. u-Blox GPS Module	55
10. RFID.....	56
10.1. NFC.....	57
10.2. Arcontia RFID Module (eTicket version only)	56

11. Barcode Scanner 58
12. USB 59

1. INTRODUCTION

This guide covers the Algiz RT7 tablet, and optional accessories.

The Algiz RT7 is a rugged tablet, designed for use by field personnel in demanding conditions. It integrates best-in-class connectivity with efficient computing and multimedia features. The tablet runs Android Marshmallow operating system, and comes pre-installed with many Google applications, including Google Play.

NOTE: The images in this guide may slightly differ from the actual screens that you see in the device.

2. REGULATORY

The 15.203 antenna requirements:

1) An intentional radiator shall be designed to ensure that no antenna other than that furnished by the responsible party shall be used with the device.

Adherence - In our design we are using customized antenna made of a carrier and conductive part (pogo spring pins) which makes contact with the antenna pads of PCB. This is not the standard type and hence any other antenna cannot be used in place of currently used antenna. This approach is applicable for both cellular as well as non-cellular RF sections. The pictures of the customized antenna are available in the above section.

2) Further, this requirement does not apply to intentional radiators that must be professionally installed, such as perimeter protection systems and some field disturbance sensors, or to other intentional radiators which, in accordance with § 15.31(d), must be measured at the installation site. However, the installer shall be responsible for ensuring that the proper antenna is employed so that the limits in this part are not exceeded.

Adherence – The antenna in our EUT (tablet) cannot to remove by a user as the antenna is fixed inside the unit. Removal of antenna requires the unit to be sent to service Centre where the professionally trained person removes/replaces/reworks the antenna if at all necessary.

2.1. Device Specification

2.1. Device Specification

The base specifications of the Algiz RT7 tablet are below:

Physical Dimensions	216.1 mm x 132.3 mm x 23.8 mm (including the shock bumpers)
Weight	650 grams (including battery)
Storage Environment	Temperature range -40 to 70 C
Operating Environment	-20 to 50C in a humidity up to 95% noncondensing
Processor	Qualcomm MSM8916 chipset, with a 64 bit quad-core ARM Cortex A53 application processor running at 1.2 GHz
RAM	2GB of LPDDR3 RAM (533MHz)
Storage	16 GB internal storage, with more than 10 GB available for user applications and data.
OS	Android Marshmallow 6.0.X Operating System.
Application Compatibility	64 bit and 32 bit applications are supported.
Display	7" WSVGA (1024x600), high-brightness (600 nits) display supporting 16 million colors.
Touch panel	5 point capacitive touch panel, chemically strengthened glass
Rear Camera	8MP rear camera with Autofocus and high brightness flash, capable of 1080p video recording
Front Camera	2MP fixed-focus front camera suitable for conferencing
WWAN	Quad-band GSM, 3G, LTE. Voice calling support. Data connectivity over 2G, 2.5G, 3G and LTE networks.
SIM slots	2 microSIM slots, DSDS (dual SIM, dual standby)
WLAN	Wi-Fi 802.11b/g/n 2.4GHz, Wi-Fi direct
Bluetooth	BT 4.1 (Classic BT + BT LE), with user selectable class 1/class 2 operation. Profiles: A2DP, HFP, SAP, DUN, AVRCP, PAN, HID, SPP, SDP, FTP, PBAP
Ethernet	10/100 Ethernet
Location	AGPS, User selectable internal GPS (Qualcomm iZat Gen8), u-Blox EVA-7M
Audio	Earpiece, Speaker, 3.5mm headset socket
Haptic Feedback	Internal vibrator
Accessibility	Four user programmable hot-keys

Input Devices	USB keyboard & mouse, BT keyboard & mouse.
Extendable Storage	Micro SD card (SDXC, up to 2TB), USB mass storage devices formatted with a single FAT partition
USB	1x B type micro USB OTG port, 1x USB A type host port
Sensors	Accelerometer, e-Compass, Gyroscope, Ambient Light Sensor, Proximity & SAR sensors.
NFC	Yes
Miscellaneous	FM player
Battery	6000 mAh lithium polymer rechargeable battery, with Fuel Gauge
Battery Charging	Fast charging via dedicated DC jack

The following optional modules are supported by the Algiz RT7:

- Barcode Scanner module
- RFID module.
The Reader is based on the 13.56 MHz contactless technology platform and is designed for increased reliability, security and high speed communication. The Smart Card Reader is intended for complete integration into the Algiz RT7 for e-ticketing and fare collection.

The Algiz RT7 is available as four SKUs:

ALGIZRT7-B-EU	This model supports the LTE bands prevalent in the European Union
ALGIZRT7-B-EU-BC	Equivalent to the ALGIZRT7-EU, with the barcode scanner module.
ALGIZRT7-B-NA	This model supports the LTE bands prevalent in the North American region.
ALGIZRT7-B-aNA-BC	Equivalent to the ALGIZRT7-NA, with the barcode scanner module

The exact LTE bands supported are listed in Table 2.1, "LTE Band Support"

TABLE 2.1. LTE BAND SUPPORT

NA Model	GSM 850 and GSM1900 (GSM900 and GSM1800 roaming) UMTS – B2, B4, B5 (B1 and B8 roaming) LTE – B2, B4, B5, B13, B17 (B1 and B8 roaming)
----------	---

1 WHAT'S IN THE BOX

The pictures shown below may differ from the actual products. To purchase additional or optional products, contact our customer centre.

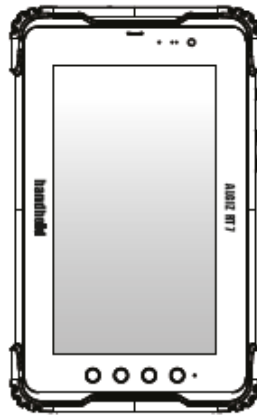

Algiz RT7 Main Body

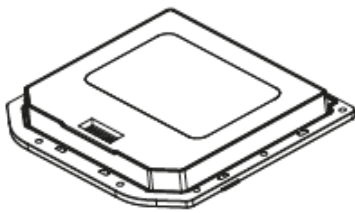

Battery Pack

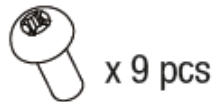

Battery Screws

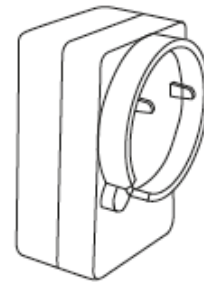

Charging Adaptor



3.5mm Barrel Connector Cable



Micro USB Cable



Headset

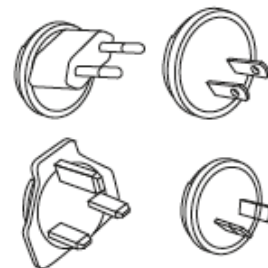

Converter Plugs

2.1.1. Barcode Scanner

The Barcode scanner module, based on the Motorola SE4710 engine, provides robust support for a wide variety of 1D/2D barcodes, as well as postal codes. Detailed specifications are below:

Scanner Engine	Motorola SE4710
Imager Resolution	1280x800 pixels
Field of View	Horizontal 42 degree, Vertical 28 degrees
Skew Tolerance	+ - 60 degrees
Pitch Tolerance	+ - 60 degrees
Roll Tolerance	+ - 360 degrees
Focal Distance	From front of engine: 7.64 in
Aiming LED	610nm LED
Illumination LED	610nm LED
Regulatory LED classification	Exempt Risk Group LED product per IEC/EN 62471

TABLE 2.2. BARCODE DECODE RANGES

	Near	Far
4 mil Code 39	3.3 in./8.4 cm	8.8 in./22.4 cm
5 mil code 128	2.8 in./7.1 cm	8.2 in./20.8 cm
5 mil code 39	2.0 in./5.08 cm	13.5 in./34.3 cm
5 mil PDF 417	3.1 in./7.9 cm	8.4 in./21.3 cm
10 mil DataMatrix	2.9 in./7.4 cm	10.1 in./25.7 cm
100% UPCA	1.8* in./4.6* cm	26.0 in./66.0 cm
20 mil code 39	2.0* in./5.08* cm	30.0 in./76.2 cm

As shown in the specifications, barcode scanning is tolerant to a wide range of orientations. Figure 2.1, “Decoding Skew” illustrates the same, measured on a 20 mil Code 39 symbol at a distance of 5 inches. Note that tolerance for skew and pitch is reduced at the extreme ends of the working range.

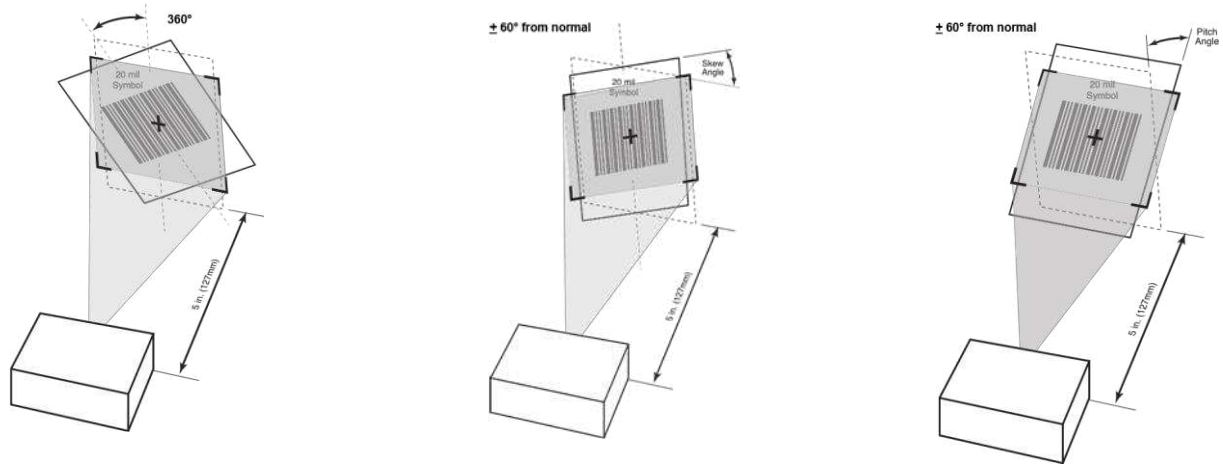

FIGURE 2.1. DECODING SKEW

2.2. Accessories

The Algiz RT7 comes with the following accessories:

- 5Vdc 2A USB Wall charger
- USB cable and DC cable
- Stereo headset with MIC and button
- Battery pack
- Quick Start Guide

For best performance, we strongly recommend that you use only the supplied charger and headset with this tablet.

2.3. Physical Layout

The front side of the device, shown in Figure 2.2, “Front Panel” is where the user interacts with the device. It consists of:

1. Front Camera
2. Light/Proximity Sensor
3. RGB LED
4. Earpiece
5. Display and Touch panel
6. 4x Hotkeys

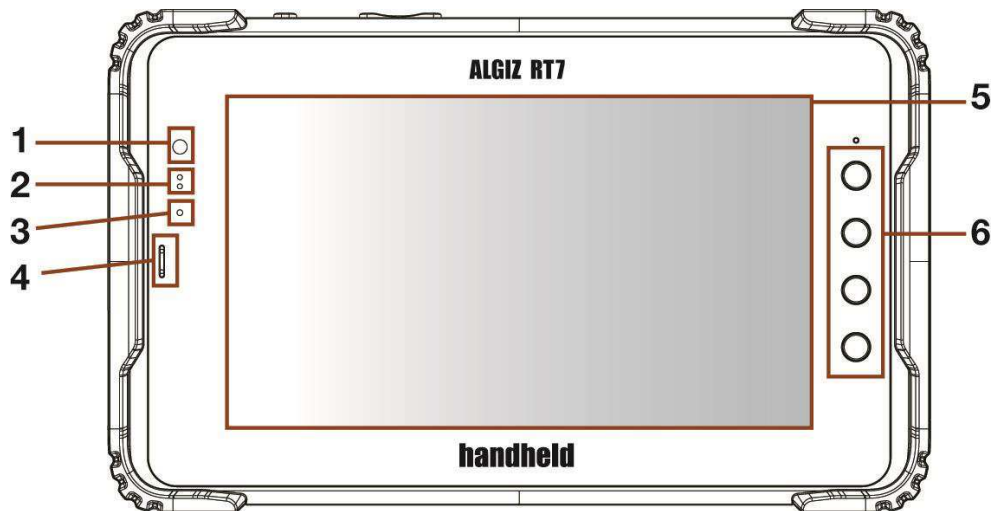

FIGURE 2.2. FRONT PANEL

The back panel (shown in Figure 2.3, “Back Panel”) includes the following items:

1. Flash LED
2. Rear Camera
3. Speaker
4. Battery Pack
5. Kensington Lock

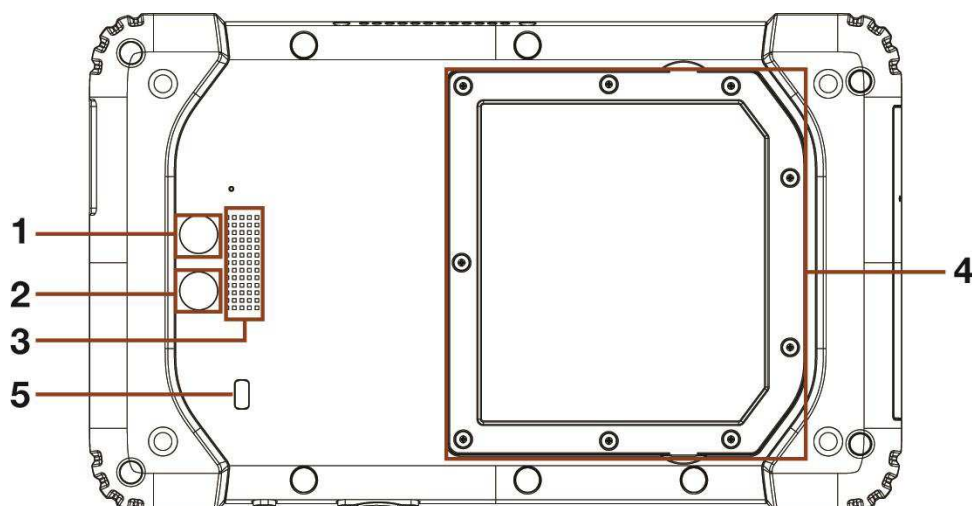

FIGURE 2.3. BACK PANEL

If the device is configured with the optional barcode scanner module, then that can be seen on the left panel, as shown in Figure 2.4, “Left Side Panel”.

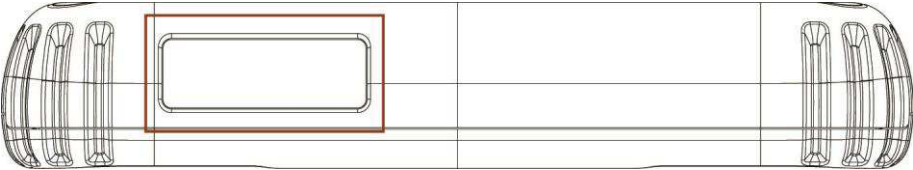

FIGURE 2.4. LEFT SIDE PANEL

The right panel of the device, shown in Figure 2.5, “Right Side Panel”, contains the port cluster with below listed ports:

- 1. Ethernet port
- 2. USB A port
- 3. Micro USB port
- 4. Audio port
- 5. DC charger port

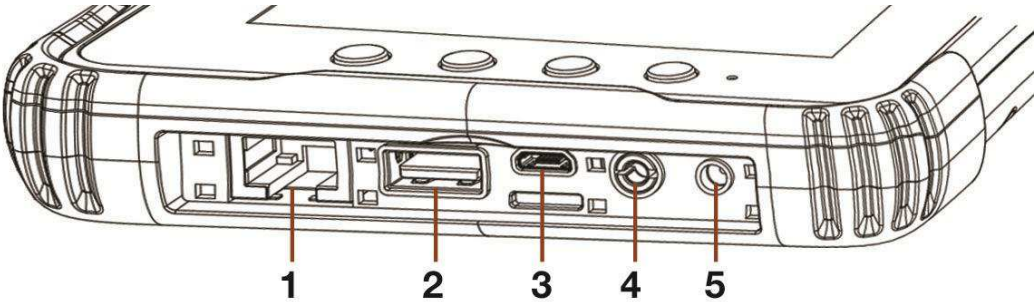

FIGURE 2.5. RIGHT SIDE PANEL

The top side of the device (shown in Figure 2.6, “Top Panel”) hosts the button panel:

- 1. Power button
- 2. Volume up & down button

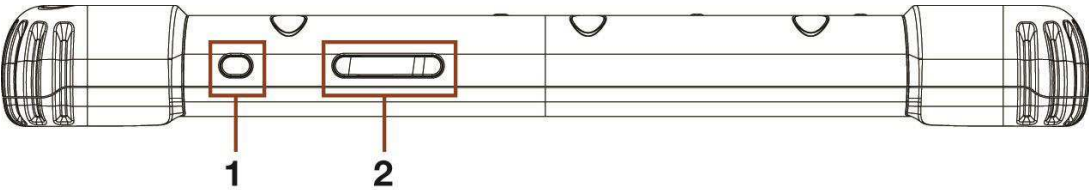

FIGURE 2.6. TOP PANEL

2.3.1. Bottom Panel



FIGURE 2.7. BOTTOM PANEL

3. DEVICE SETUP

3.1. SIM Card Insertion

This tablet supports two SIM cards. There are two slots on back side of tablet as shown in Figure 3.1, “SIM Card Slots”.

The device supports the dual SIM dual standby configuration. Both the SIM cards can be used. However, only one of them can be used for phone calls at any time.

To insert a SIM card:

1. Power OFF the tablet.
2. Place the tablet on flat surface, with the screen facing down.
3. Remove the battery pack.
4. Insert the SIM card.



FIGURE 3.1. SIM CARD SLOTS

You can see more details about inserted SIM cards in Device Setup

Settings → Wireless & networks → SIM cards

3.2. SD Card

This tablet supports a single microSD card for secondary storage. SD card slot is on back side of tablet, under the battery cover, as shown in Figure 3.2, “SD Card Slot”. –



FIGURE 3.2. SD CARD SLOT

Once SD card inserted successfully, you can check its details in

Settings → Device → Storage → SD card

3.3. Charging the device

We recommend that you fully charge the battery prior to first use. A high power DC jack is provided; we recommend that this is used to charge the device.

When a charger is connected, the charging LED on the device gives a visual indicator of the state of charge:

Green LED	Green indicates that the battery is fully charged
Yellow/ Orange LED	Yellow/orange indicates that the battery capacity is above 15%
Red	Red indicates that the battery is charged to less than 15%

During low battery conditions (<15% charge), the LED will blink red when the device is in use without a charger being connected.

In rare cases, during use, the battery may discharge to a very weak state. In such a state, when a user attempts to turn on the device using the power button, the device may not respond. To recover from this, connect the charger to the device. The LED will then glow red, and stay that way for a few minutes. The device will then boot into charging mode.

4. BASIC USAGE INSTRUCTIONS

The Algiz RT7 runs Android Marshmallow. The Algiz RT7 is packed with the same features you would expect in a feature-rich tablet/smartphone. The device provides the intuitive Android user interface with no modifications. If you are already familiar with any Android device, then you will feel right at home using this device.

The Algiz RT7 can be used in all screen orientations. However, the portrait and landscape orientations would be the preferable orientations for most applications.

4.1. Power ON

To power ON the tablet, press and hold the power button for 3 seconds.

- The power button can also be used for other functions:
- When the tablet is ON, tap the power button to wake up the device or send it to sleep. The tablet uses minimum power when it is asleep.
- When the tablet is ON, press and hold the power button to bring a menu of actions.
- In rare cases, if the tablet stops responding to any input for a long time, you can press and hold the power button for about 10 seconds to hard reset the tablet.
- If, after a single press of the power button, the display does not turn on, please press the power button a second time. This will power up the display after an ESD event.

4.2. Audio Volume

Use volume buttons to control the audio volume of tablet. Pressing the volume buttons will pop up the volume indicator on top of the screen as shown in Figure 4.1, "Volume Indicator"

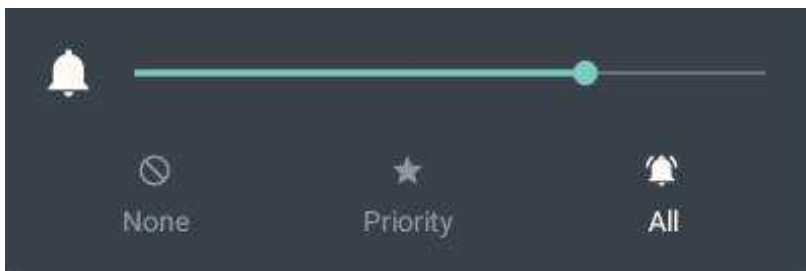

FIGURE 4.1. VOLUME INDICATOR

4.3. Initial Startup

When the device is first powered on, it boots into the startup interface. This interface guides you step by step through the device setup process. You can configure the language of usage, time zone, date & time settings. At this time, the tablet also connects to the internet using any available data network via the SIM cards. If no network is available, then you get an option to connect to any available Wi-Fi network. Optionally, you may also associate a Google account with the device at this time. Doing this is highly recommended. A Google account is required for using many pre-installed Google applications like Gmail. A Google account is required for installing applications from the Google Play Store.

Once you are through the setup process, then the device is ready to use.

4.4. Home Screen

The tablet boots to the home screen after initial startup, as shown in Figure 4.2, “Home screen”.

- You can start various applications by touching their icons.
- The top of the screen is the status bar, which shows:
 - On the right side, the current system time, battery status and connectivity status.
 - On the left side, notification icons. To see notifications, swipe down with a finger.
- To see the all the installed applications, touch the icon at the center.

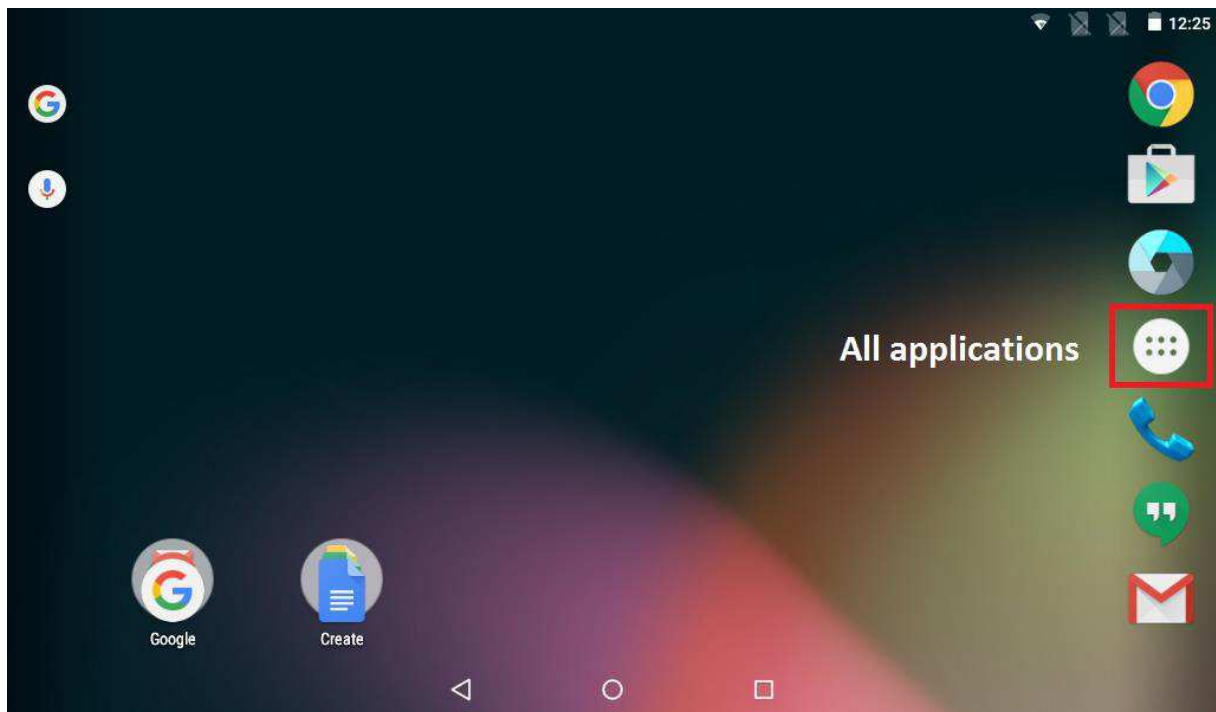

FIGURE 4.2. HOME SCREEN

4.4.1. Navigation Bar

At the bottom of the screen, you will find the Navigation Bar with three soft buttons. The three buttons, in order are:

1. Back Button. Touching this generally takes you to the previous screen. The exact behavior may depend on the active application.
2. Home Button. Touching this takes you to the home screen.
3. "Recent Apps" Button. Touching this shows you the running applications. You may directly switch to another application by touching on it.

4.5. Applications Screen

This screen (see Figure 4.3, "All Applications") shows the installed applications, and allows you to start any application of your choice. Your device may have more apps installed than can be shown on the screen; swipe the screen left and right to navigate.

Touch any app icon to start it.

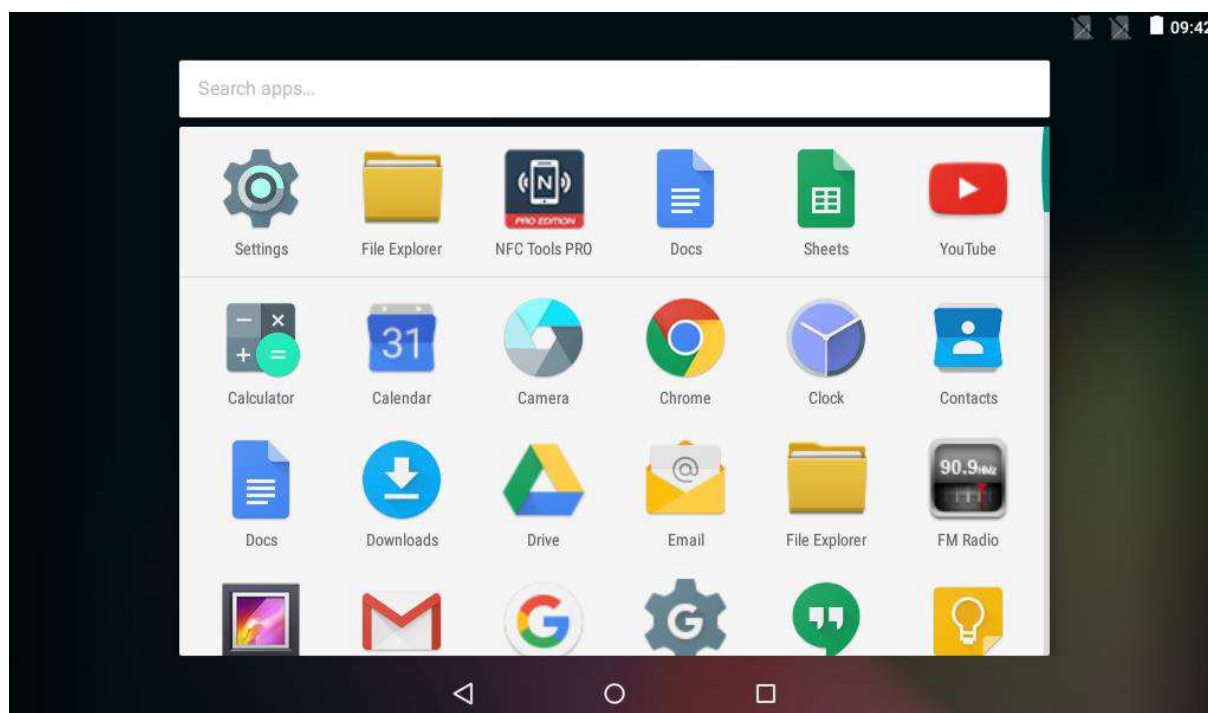

FIGURE 4.3. ALL APPLICATIONS

If you are using an app frequently, then you may place it on home screen for quicker access. To move an app to the home screen:

1. Touch and hold the application icon
2. Select the screen by sliding the finger
3. Lift the finger to drop the application icon

If you want to remove an application from home screen:

1. Touch and hold the application icon
2. Move the finger towards top-left corner of screen
3. Drop the application icon on "Remove" icon

If you want to see detailed information about any app. Touch and hold the application icon. Drop it over "Info" icon on top-left corner of screen. You can also view and manage applications using "Apps" settings (see Section 5.2.7, "Apps").

4.6. Lock Screen

The default lock screen of the device is shown in Figure 4.4, “Lock Screen”. When the device wakes up from sleep, this screen becomes visible.

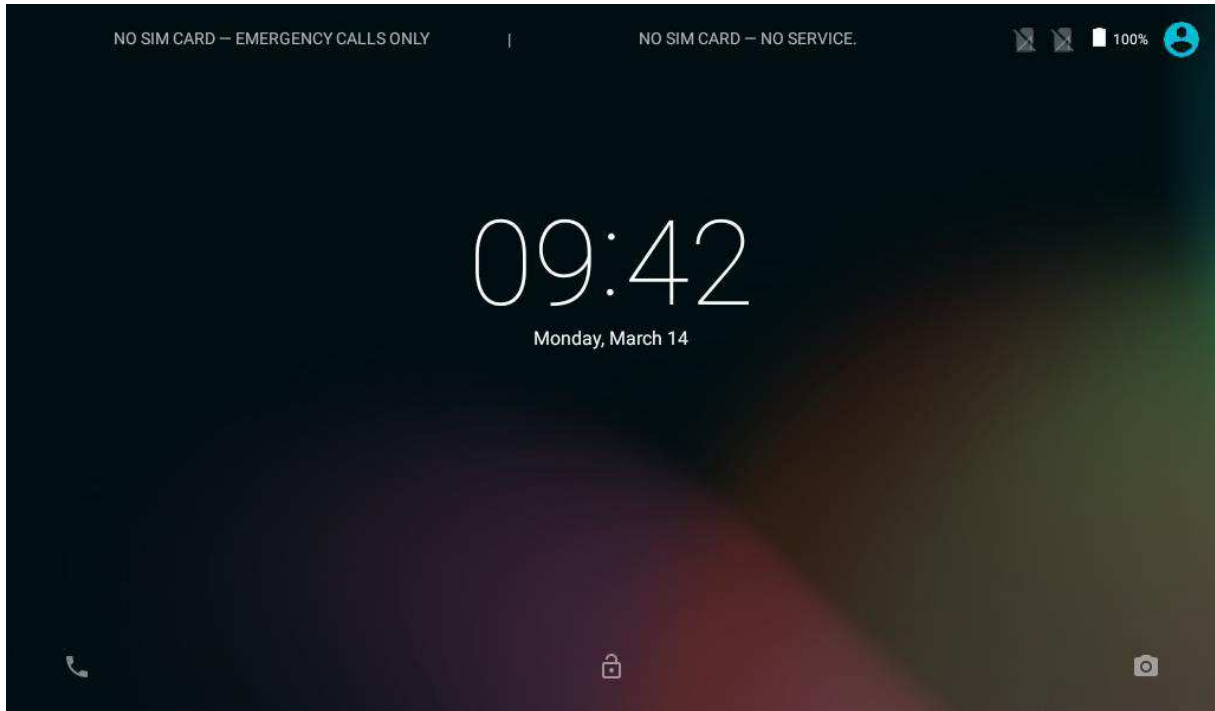

FIGURE 4.4. LOCK SCREEN

For ready reference, the lock screen shows the status of the SIM cards on the top.

4.7. Quick Settings

Common settings may be quickly accessing using "Quick Settings". To access Quick Settings, simply swipe down from the top of the screen. From Quick Settings (see Figure 4.5, "Quick Settings"), you may change the screen brightness, connect to Wi-Fi networks, Bluetooth devices and SIM networks, as well as control automatic screen rotation.

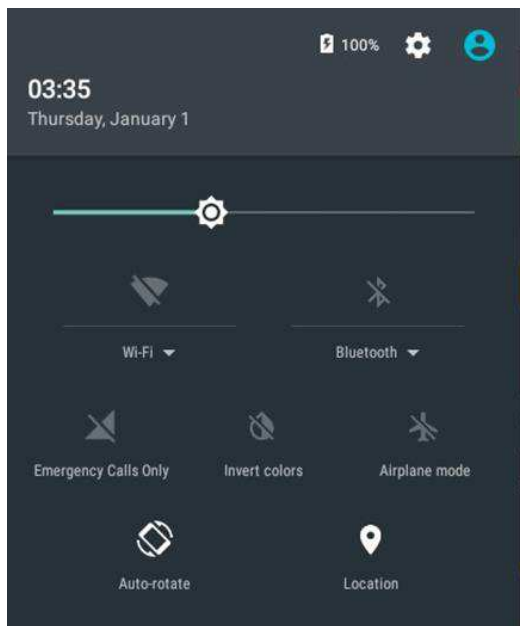

FIGURE 4.5. QUICK SETTINGS

4.7.1. Adjusting Screen Brightness

In Quick Settings, drag the slider to set the screen brightness.

4.7.2. Control Wi-Fi

Touch the Wi-Fi icon to quickly enable/disable Wi-Fi.

4.7.3. Control Bluetooth

Touch the Bluetooth icon to quickly enable/disable Bluetooth

4.7.4. Invert Screen Colors

In very brightly lit environments, you may have trouble reading the contents of the screen. The "Invert colors" option reverses the colors (i.e. black becomes white, and vice versa). This may help readability. This mode is most effective for reading text on the screen. Due to the color inversion, it is not recommended if you are looking at images.

4.7.5. Airplane Mode

Airplane mode disables all radios. One touch on the Airplane mode icon enables/ disables airplane mode.

4.7.6. Screen Auto-Rotate

By default, the applications on the screen follow the orientation of the device. You may change this to force applications to lock to the current screen orientation (portrait/ landscape).

4.7.7. Location

This option controls the location usage of applications. If this option is turned off, then Android apps & services do not get location data.

4.8. Make a Phone Call/SMS

Use the Phone app to make phone calls. This app shows the call history as well. Use the headset included with the device for comfort. The button on the headset can be used to accept/reject/hang-up calls.

The Hangouts app can be used to send/receive SMS.

4.8.1. Pair a Bluetooth headset

A Bluetooth headset may be used during phone calls for maximum comfort. To use a Bluetooth headset, you need to pair it with the tablet first. Refer to Section 5.1.2, “Bluetooth” for detailed instructions. Once the headset is paired, it will be used during phone calls.

4.9. Connect to a Network

If a SIM is inserted into the tablet, and you are subscribed to a data plan, then the tablet will automatically connect to the internet.

If a Wi-Fi network is available, you may also connect to it; see Section 5.1.1, “Wi-Fi” for instructions on how to connect. A wired data connection is possible using Ethernet too; see Section 5.1.4, “Ethernet” for detailed instructions.

4.10. Configure Google Account

A Google account is required for making the most use of many applications installed on the device. If you did not configure a google account on startup, then you can add one from Settings | Accounts.

4.11. Useful Applications

The Algiz RT7 ships with many useful applications. Please see Section 5.6, “Applications” for details..

4.11.1. Install Applications

Please use the Google Play application to install applications from the Google Play store. Note that a Google account is required for this.

4.12. Configure Hotkeys

The Algiz RT7 has four user configurable hot keys. Each of the keys may be independently mapped to various functions. Please see Section 5.5, “User Configurable Hotkeys” for details.

4.13. Notifications

Android applications use notifications to indicate to the user that some action is required. In general, two types of notifications are supported:

- Notifications in the user interface. These show up on the top of the screen. Users can see details by swiping down on the screen. Android supports rich notifications. Users may respond to notifications by touching. All active notifications can be dismissed as well with a single touch.
- LED notifications: Some applications use LED notification lights to indicate to the user that some action is required. LED notifications are only visible when the device screen is off. A blinking blue LED indicates that a notification is active. Typically, this corresponds to incoming messages (SMS, email) and missed calls.

4.14. Scanning Barcodes

If your table is equipped with the optional barcode module, then you may directly scan barcodes with the press of a button. Any of the four hotkeys can be configured to scan barcodes. See Section 5.5, “User Configurable Hotkeys” for details. The scanner can decode a wide range of barcode symbologies. Section 5.2.6, “Barcode” shows how the scanner be configured to selectively scan specific symbologies.

4.15. Software Updates

You may check for Software Updates to the tablet from Settings | About Tablet.

4.16. Factory Reset

To reset the device to the default state, you may use the Factory Reset functionality. Note that this will remove all installed apps and data. The factory reset option is available from Settings | Backup and Reset.

This tablet includes a safety feature known as "factory reset permission". If any Google Account is associated with the device, then you will need to login to that account when the device reboots post the factory reset.

If you are planning to associate another google account with the device after factory reset, then it is highly recommended that you remove the google account before issuing the factory reset.

5. SETTINGS

The Settings application can be used to connect to various networks, as well as configure the wide variety of options available. The Settings applications may be accessed from the applications screen. Swiping down the screen and touching on the settings icon is a faster way to reach there.

Many applications will have its own settings, which can accessed by using menu icon on top right corner.

The Settings application groups controls under four categories, as below:

- Wireless & networks
- Device
- Personal
- System

5.1 Wireless & network

To perform network related settings, select respective option under Wireless & network settings as shown in Figure 5.1, "Wireless & networks Settings".

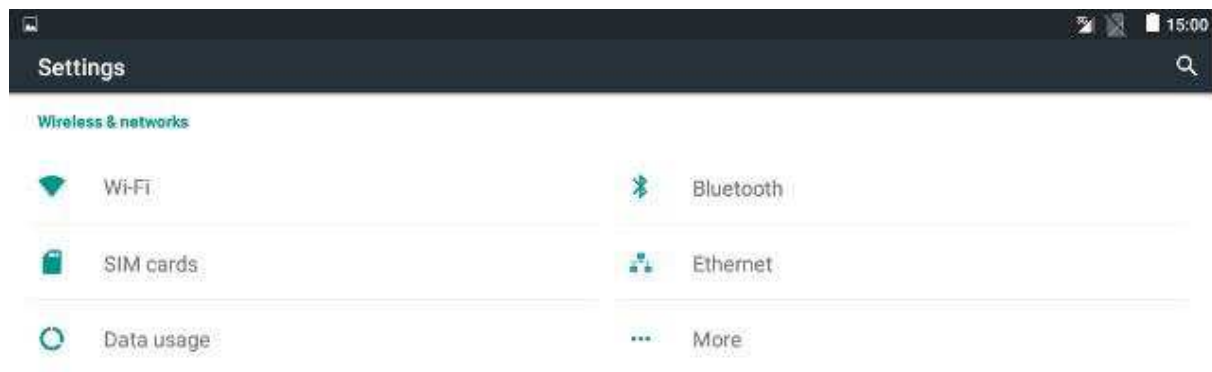

FIGURE 5.1. WIRELESS & NETWORKS SETTINGS

5.1.1. Wi-Fi

To perform Wi-Fi related settings select the "Wi-Fi" option under Wireless & network group in settings as shown in Figure 5.2, "Wi-Fi Settings".

When the tablet is powered ON for the first time Wi-Fi will be OFF as shown in Figure 5.3, "Wi-Fi Off". To connect to Wi-Fi network:

1. Turn ON Wi-Fi.
2. Select a network from available list of networks as shown in Figure 5.4, "Available Wi-Fi networks"
3. If a password is required to connect to the network, then you will be prompted to enter the password, as shown in Figure 5.5, "Password to connect"

If the device is successfully able to connect to the network, then the network status is shown, as in in Figure 5.6, "Wi-Fi connected status".

Touching the connected Wi-Fi network pops up all the properties of the network: IP address, Status, Signal strength, Link speed, Frequency and Security.

You may perform operations like, add network, view saved networks, refresh by using menu icon on top right corner. You can check the current Wi-Fi status from home screen by scrolling down from the top.

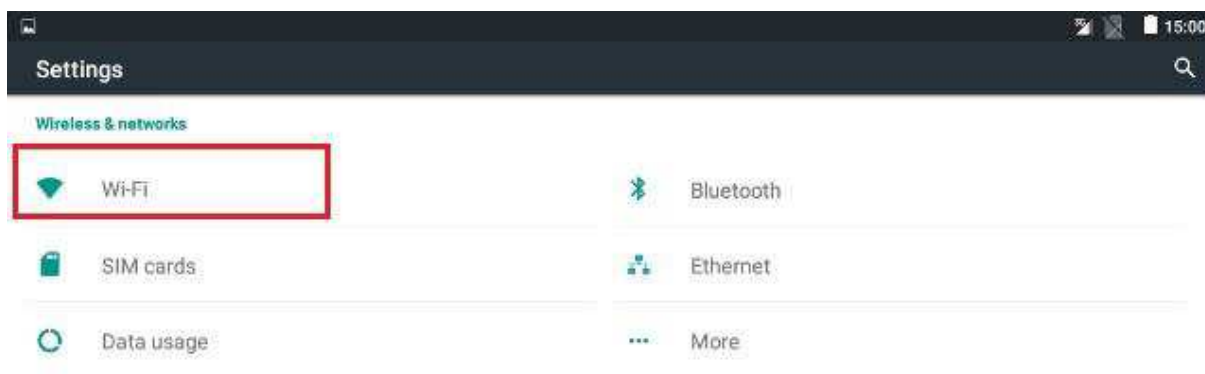

FIGURE 5.2. WIFI SETTINGS



FIGURE 5.3. WIFI OFF

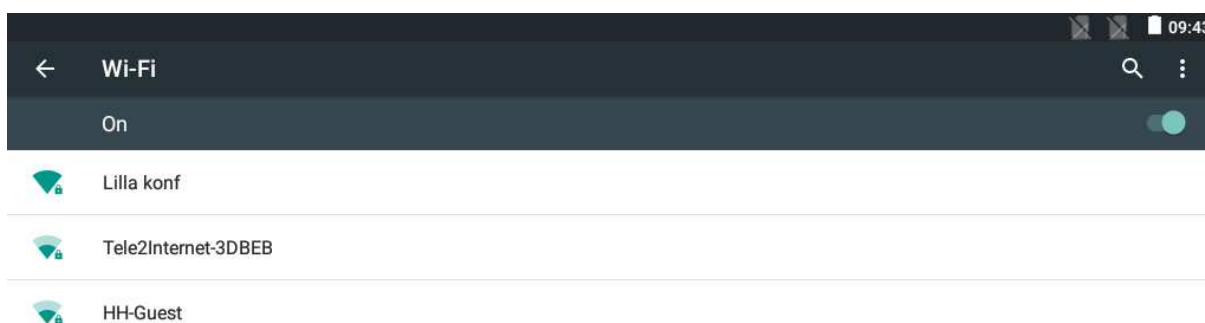

FIGURE 5.4. AVAILABLE WIFI NETWORKS

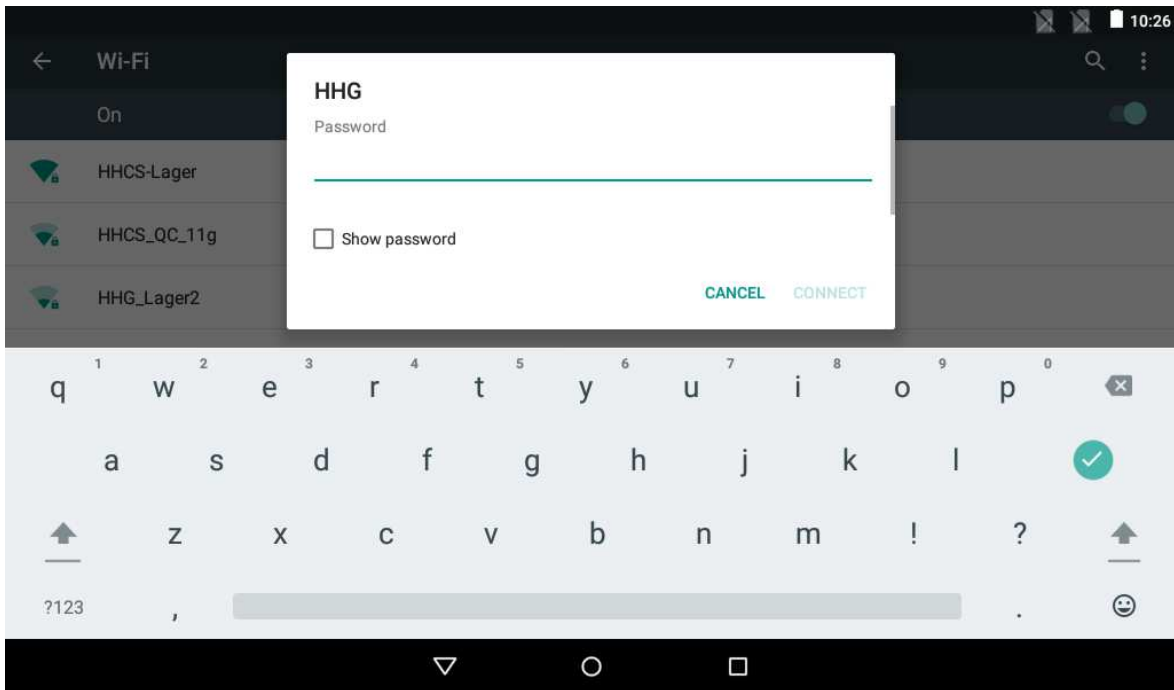

FIGURE 5.5. PASSWORD TO CONNECT

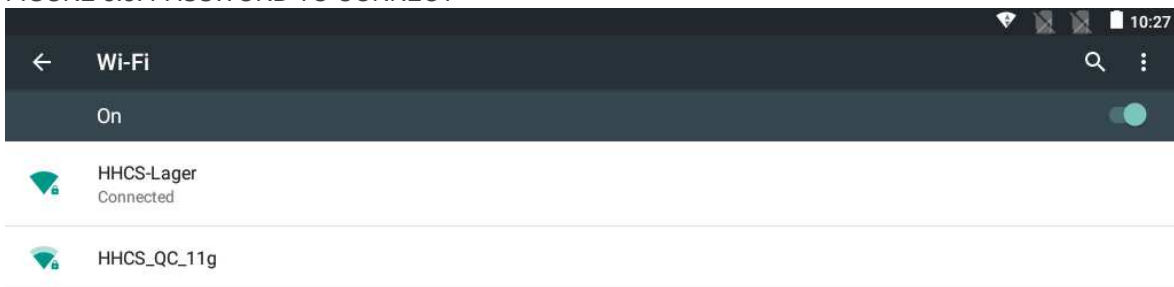

FIGURE 5.6. WIFI CONNECTED STATUS

5.1.2. Bluetooth

Bluetooth related settings are under the "Bluetooth" option under "Wireless & network settings" group, as shown in Figure 5.7, "Bluetooth Settings".

When the tablet is powered ON for the first time Bluetooth will be OFF as shown in Figure 5.8, "Bluetooth OFF".

Prior to using a Bluetooth device, you need to pair the device with the tablet, as follows:

1. Turn on Bluetooth.
2. Select the device from "Available devices" list as shown in Figure 5.9, "Available device list".
3. Touch "PAIR" on Bluetooth pairing request as shown in Figure 5.10, "Pair Request".

Now, you can see the selected device under "Paired devices" list (shown in Figure 5.11, "Paired devices list").

You can do additional operations like renaming the device, Refresh, View all received files by touching menu icon on top-right corner see Figure 5.12, "Bluetooth Settings Menu".

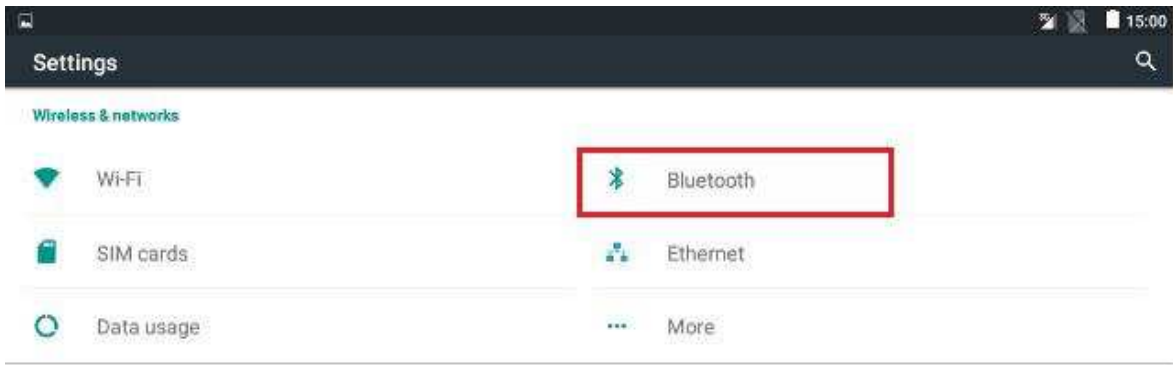

FIGURE 5.7. BLUETOOTH SETTINGS



FIGURE 5.8. BLUETOOTH OFF

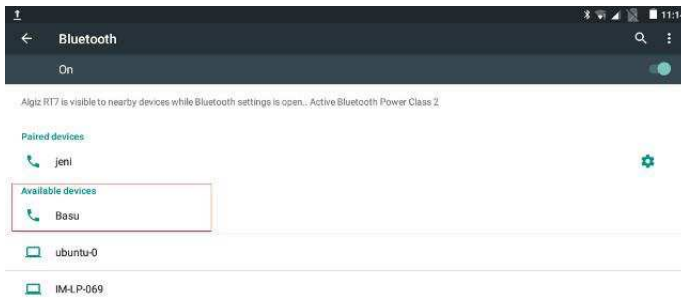

FIGURE 5.9. AVAILABLE DEVICE LIST

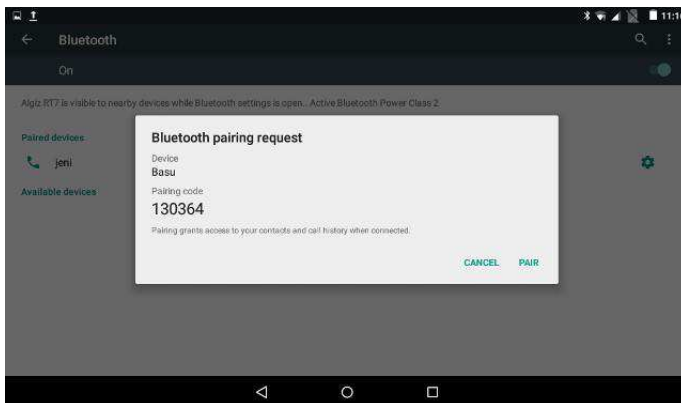

FIGURE 5.10. PAIR REQUEST

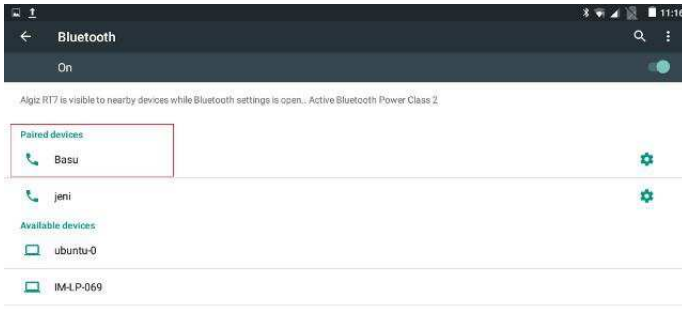

Figure 5.11. Paired devices list

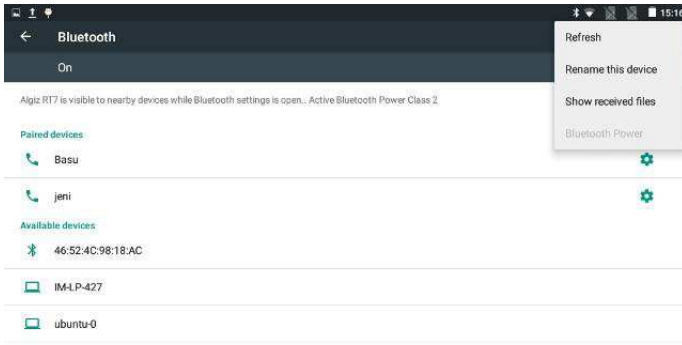

FIGURE 5.12. BLUETOOTH SETTINGS MENU

Configurable Bluetooth Power Class

The Bluetooth interface on the Algiz RT7 may be configured to run at two power levels:

- Class 2 operation. This is the default, and provides a short range of operation.
- Class 1 operation. This is a high power mode, providing a longer range of operation.

To make effective use of the higher power, both devices must operate in Class 1.

To change the power class, select the "Bluetooth Power" menu option from Bluetooth configuration, as shown in Figure 5.13, "Select Bluetooth Power from Bluetooth Settings". This option is available when Bluetooth is off; it is disabled when Bluetooth is on. The user can then select the required power class, as shown in Figure 5.14, "Select Power Class". The active Bluetooth power class is shown when Bluetooth is enabled, as shown in Figure 5.15, "Bluetooth Status".

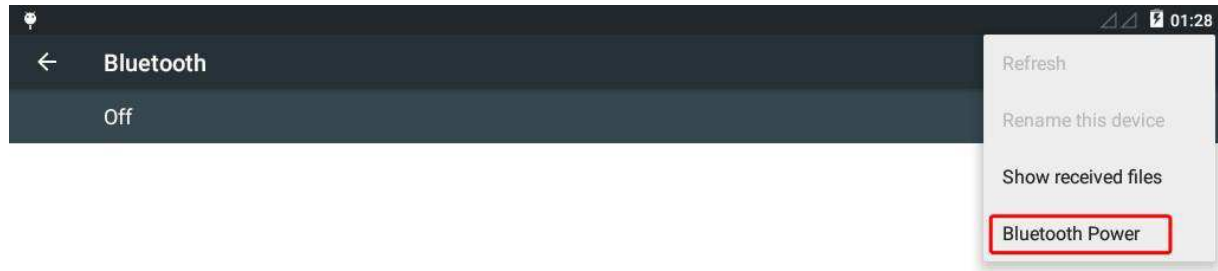

When Bluetooth is turned on, your device can communicate with other nearby Bluetooth devices.



FIGURE 5.13. SELECT BLUETOOTH POWER FROM BLUETOOTH SETTING

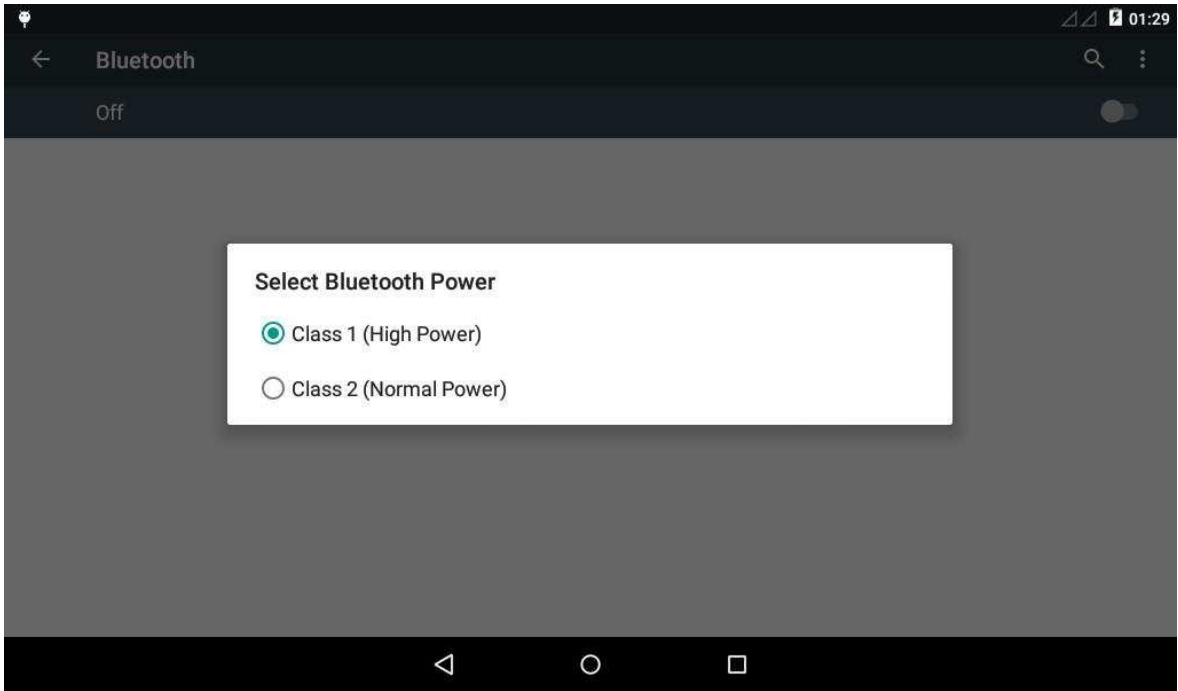

FIGURE 5.14. SELECT POWER CLASS

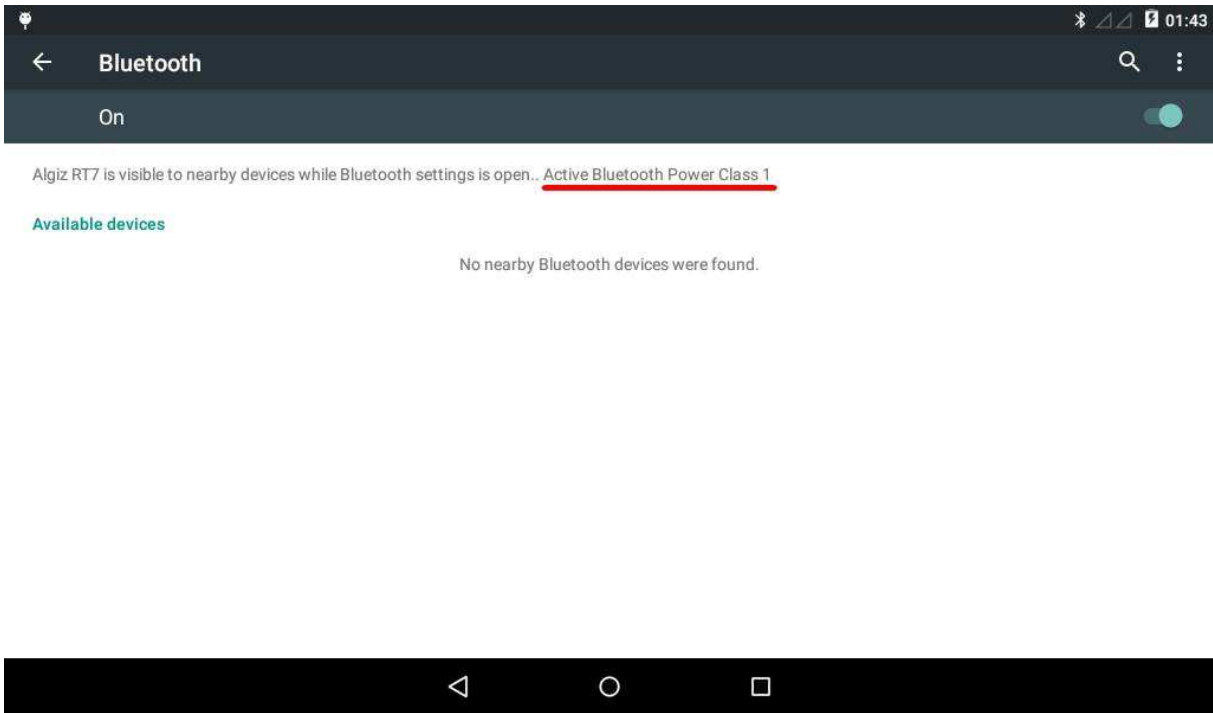

FIGURE 5.15. BLUETOOTH STATUS

5.1.3. SIM cards

The Algiz RT7 supports up to two SIM cards in a Dual SIM, Dual Standby (DSDS) configuration. The SIM cards screen (see Figure 5.16, "SIM Cards") allows you to configure your preferences for the inserted SIM cards.

Either SIM card may be individually enabled/disabled, you may also configure preferred SIM to use for data or voice calls.

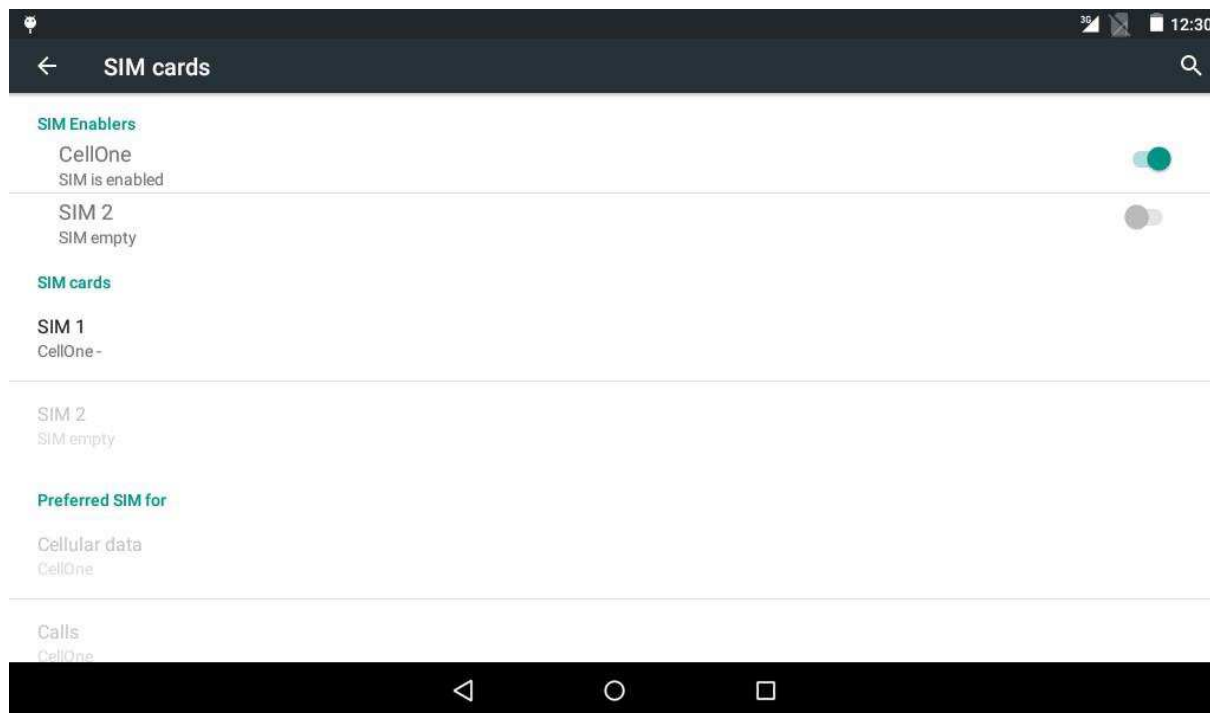

FIGURE 5.16. SIM CARDS

5.1.4. Ethernet

To connect to an Ethernet network, use the "Ethernet" option under Wireless & networks settings. The "Enable Ethernet" option (shown in Figure 5.17, "Ethernet options") allows you to turn ON or turn OFF the Ethernet connection as needed.

The "Ethernet IP Assignment" option provides two methods of configuring the Ethernet port:

- Automatic IP address configuration using DHCP. This is on by default.
- Static IP address.

You may directly assign the properties of the Ethernet port using "Static IP" option. To do this, you need to have the following information handy:

- The IP address you wish to assign to the device.
- The netmask of the network you are connecting to.
- The IP address of the gateway.
- The IP address of the DNS server.

All the IP addresses (interface address, gateway, DNS) are entered in dotted IP notation e.g. "192.168.100.152". The netmask needs to be entered in CIDR format, e.g. "24" is equivalent to "255.255.255.0".

To configure the static IP:

1. Change "Ethernet IP Assignment" option to "Static IP".
2. Select "Static IP Settings" as shown in Figure 5.18, "Ethernet IP assignment methods".
3. Enter the values in Static IP configuration dialog as shown in Figure 5.19, "Static IP configuration dialog".

You can see the information about the Ethernet port by selecting "properties" option in menu at the top-right corner. A dialog pops up with information. This dialog shows the MAC address of the Ethernet port, as shown in Figure 5.20, "Ethernet properties".

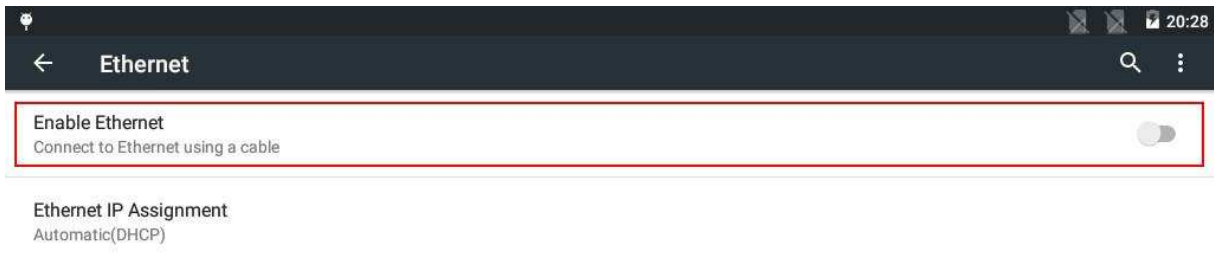

FIGURE 5.17. ETHERNET OPTIONS

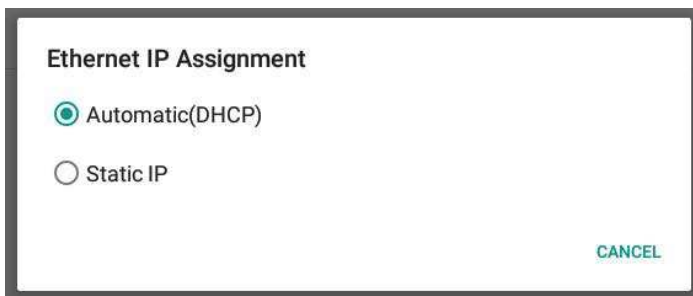

FIGURE 5.18. ETHERNET IP ASSIGNMENT METHODS

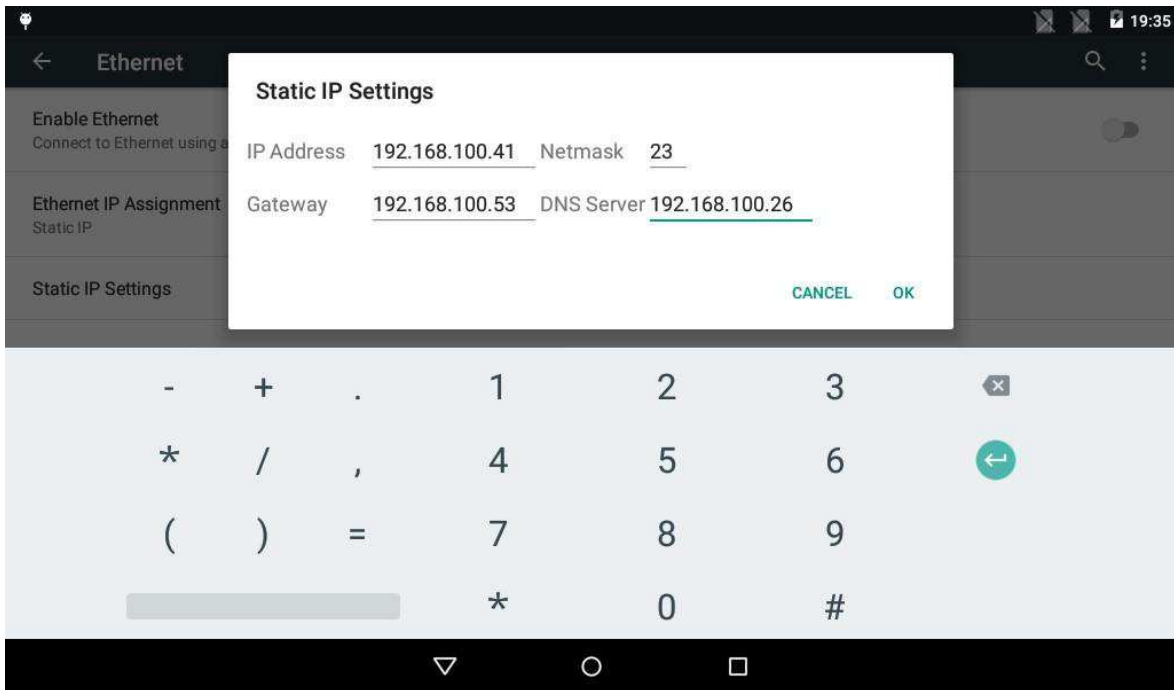

FIGURE 5.19. STATIC IP CONFIGURATION DIALOG

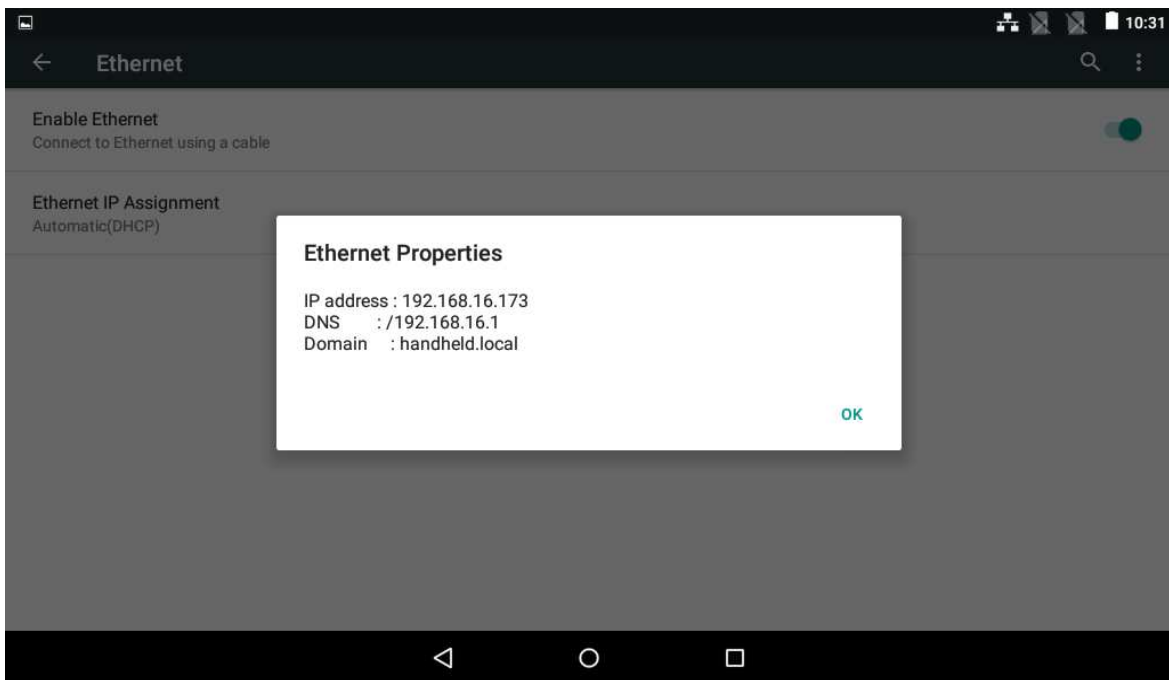

FIGURE 5.20. ETHERNET PROPERTIES

5.1.5. Network Selection Policy

The data networks on the tablet, in order of priority, are

- Ethernet (highest)
- Wi-Fi
- SIM based networks (lowest)

Only one data network may be active on the tablet at a time. When a connection to any network of higher priority is available, then the lower priority networks are disabled automatically. As an example, when Wi-Fi is enabled, it takes priority over 2G/3G/4G networks. Similarly, when an Ethernet connection is established, it takes precedence over all other networks.

5.2. Device

You can use device settings to set device properties such as display, sound, battery, storage etc. as shown in Figure 5.21, “Device Settings”.

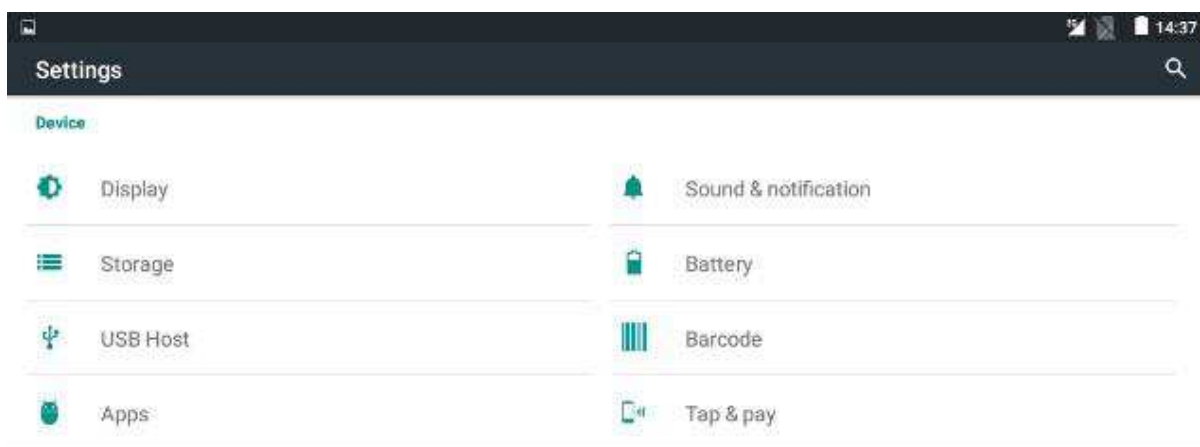

FIGURE 5.21. DEVICE SETTINGS

5.2.1. Display

The "Display" option under Device settings allows you to set below display properties for your tablet (shown in Figure 5.22, "Display Settings").

1. Brightness level - Adjust the slider to set the brightness level (see Figure 5.23, "Brightness Settings").
2. Adaptive brightness - Enabling this option sets the brightness level of the screen appropriately for the available light. The adaptive brightness function uses a very low backlight level in pitch darkness, reasonable level in typical indoor office lighting, and maximum brightness while using the tablet outdoors or in direct sunlight. Using this option gives reasonable power savings, and is recommended.
3. Wallpaper - Personalize your device. You may select an image from Gallery, Live Wallpapers or Wallpapers.
4. Sleep - This sets the idle timeout after which the device goes to sleep. You may set a value between 15 seconds and 30 minutes as shown in Figure 5.24, "Sleep time options". The "never" setting may be used when you do not want the screen to go to sleep automatically. This is typically used for benchmarking the device. Using this option can drain the battery faster than normal. If very long operation times are required, then we recommend that you keep the charger connected.
5. Daydream - to control what happens when the phone is docked and/or sleeping. You can set clock, colors, and photo frame or photo table as daydream. Using menu you can specify when to daydream (while docked, while charging or either).
6. Font size - to the set the font size to small, normal, large or huge. Larger sizes make for easier reading, at the cost of showing less content on screen.
7. When device is rotated - to set what should happen for the content of the screen when screen is rotated. You can set rotate the contents or stay in current orientation.
8. Cast screen - by enabling wireless display option in menu, you may mirror the tablet display onto another display that is connected to a Miracast dongle.

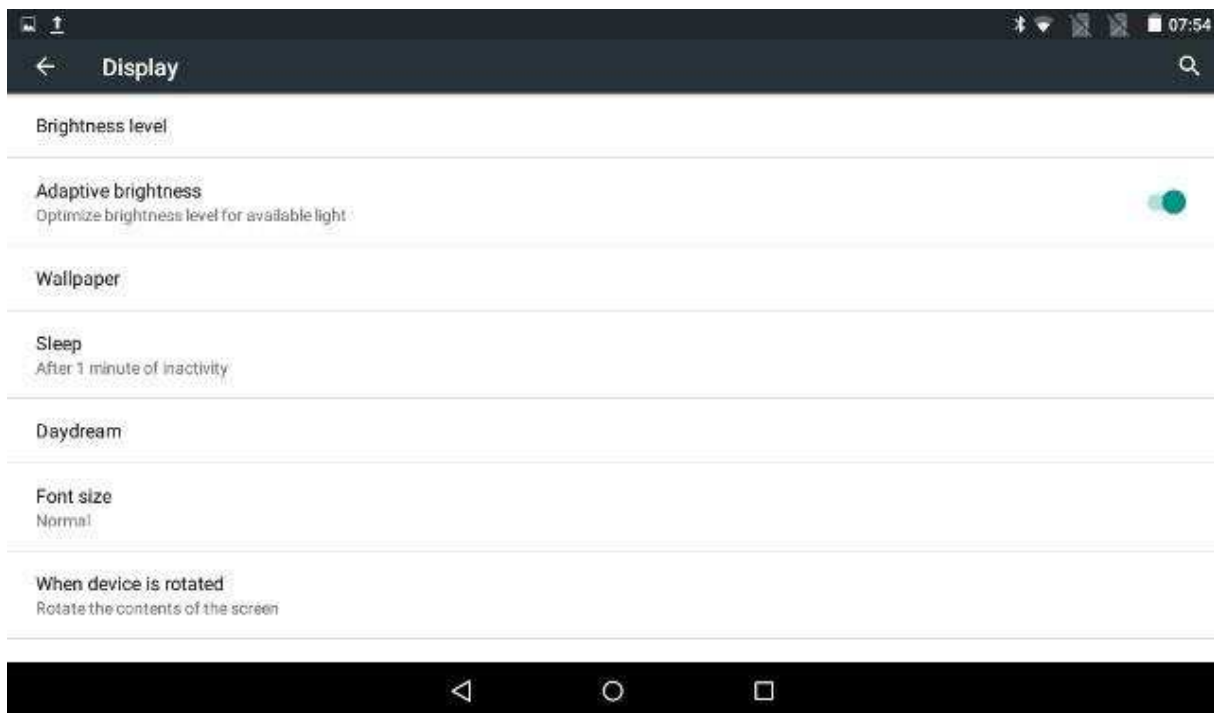

FIGURE 5.22. DISPLAY SETTINGS



FIGURE 5.23. BRIGHTNESS SETTINGS

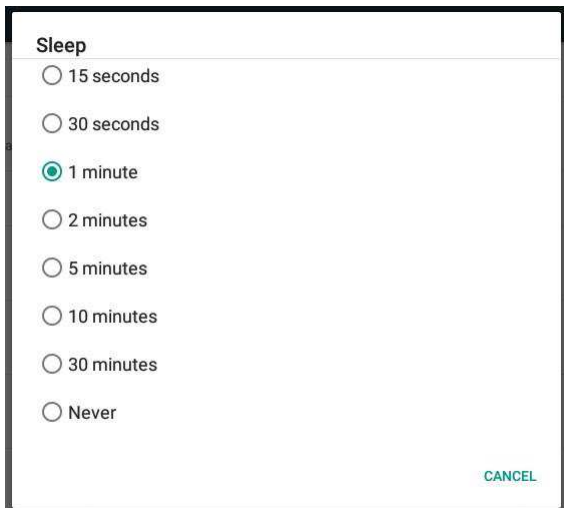

FIGURE 5.24. SLEEP TIME OPTIONS

5.2.2. Sound & notification

This option allows you to control below sound and notification properties for your tablet (shown in Figure 5.25, "Sound & notification Settings").

1. Sound

- a. Media volume - to set volume for media file such as videos, audio songs etc. by scrolling from left to right.
- b. Alarm volume - to set volume for alarm ring.
- c. Ring volume - to set volume for phone ring tone.
- d. Also vibrate for calls - turn on/off vibrator during incoming phone calls.
- e. Interruptions - to set the interruption for calls and notifications. You can set Always interrupt, don't interrupt or priority interruption by specifying the time interval. You can set the priority interruptions for Events & reminders, calls and messages.
- f. Phone ringtone - to set phone ringtone from list of ringtones available.
- g. Default notification ringtone - to set ringtone for notification.
- h. Other sounds - to set enable sound for dial pad, screen locking and touch. You can also enable vibrate for touch.

2. Notification

- a. When device is locked - to enable/disable notification content view when tablet is locked.
- b. App notification - to set notification priority for applications installed in your tablet. You can also block the notification from an application.
- c. Notification access - to set the listeners for notification.

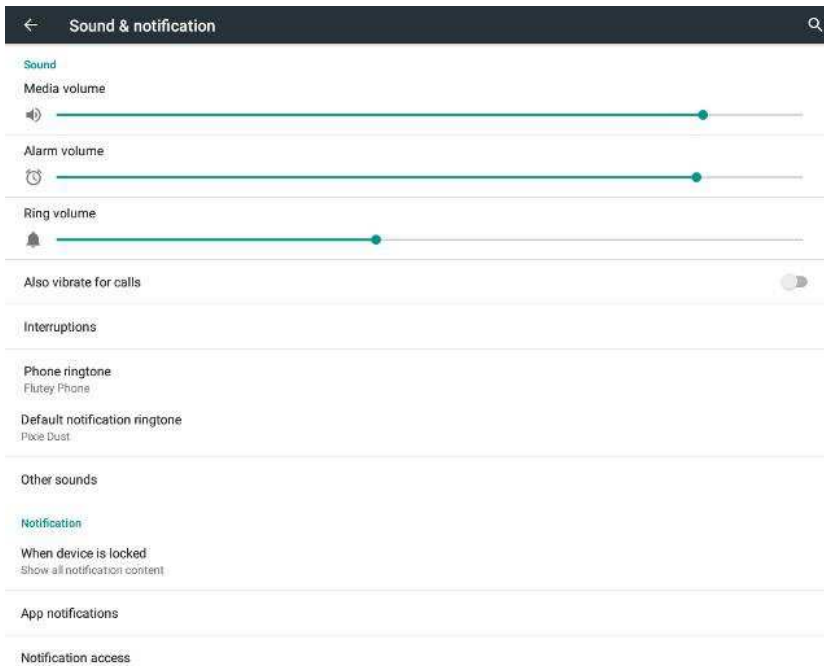

FIGURE 5.25. SOUND & NOTIFICATION SETTINGS

5.2.3. Storage

This option allows you to view and control the below storages supported by your tablet. • Internal storage

It displays total space allowed to store under internal storage, currently available space and list of all applications using internal storage with space used as shown in Figure 5.26, “Internal storage Settings”.

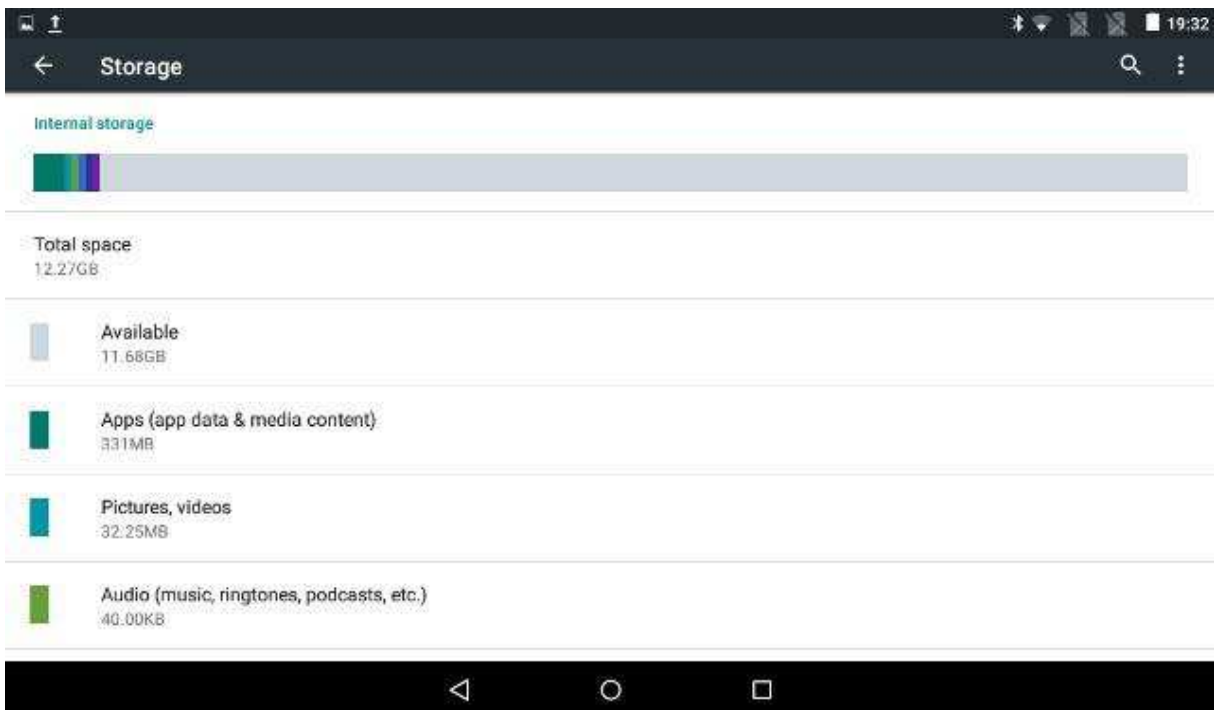

FIGURE 5.26. INTERNAL STORAGE SETTINGS

- SD card

It displays total space allowed to use, currently available space in SD card.

Unmount SD card - to unmount the SD card before removing it, to avoid data loss.

Erase SD card - to remove all the data stored in the SD card.



FIGURE 5.27. SDCARD STORAGE SETTINGS

- USB storage

It displays total space allowed to use, currently available space in USB storage.

Unmount USB storage - to unmount the USB device before removing it, to avoid data loss.

Erase USB storage - to remove all the data stored in the USB.



FIGURE 5.28. USB STORAGE SETTINGS

5.2.4. Battery

This option allows you to view the current battery status and usage as shown in Figure 5.29, "Battery Settings".

It also shows the percentage of battery used by screen and other applications since last full charge.

You can do refresh for the current battery status using REFRESH option on top-right corner.

You can enable "Battery saver" option in menu. Using "Turn on automatically" option you can specify when battery saver should turn on automatically (at 5% battery, at 15% battery or never).

To improve battery life, battery saver reduces your tablet performance.

Battery saver turns off automatically when your tablet is charging.

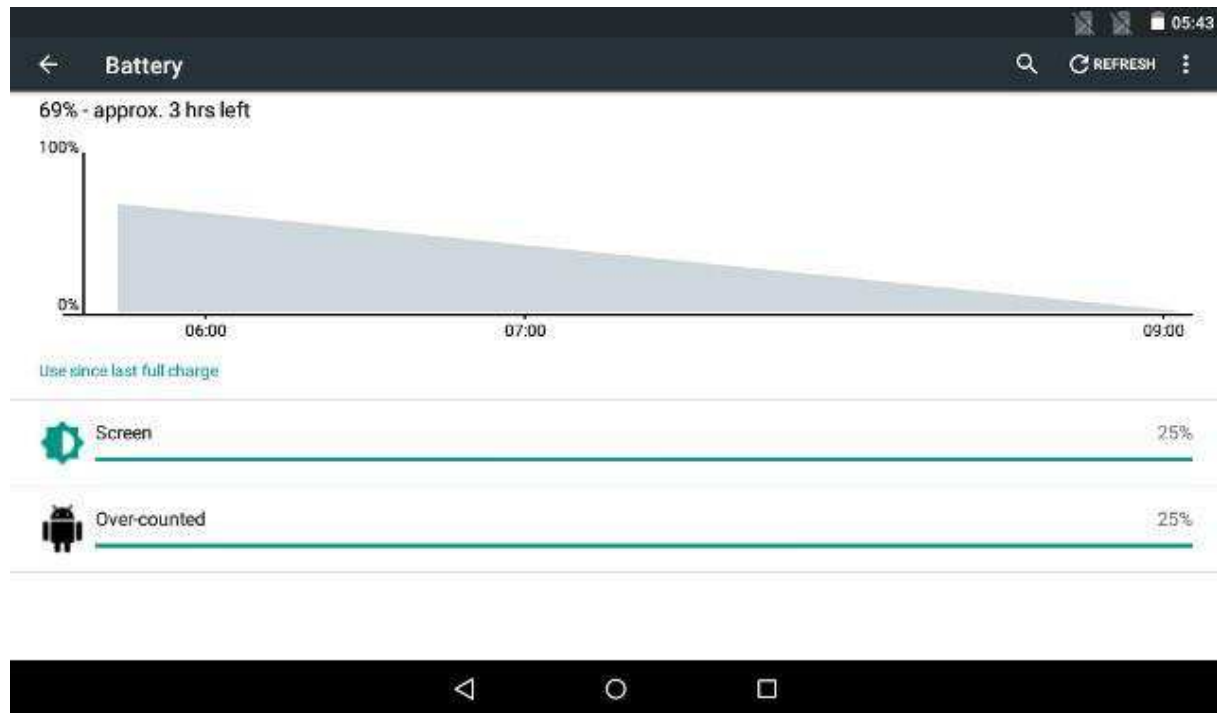

FIGURE 5.29. BATTERY SETTINGS

5.2.5. USB Host

This setting option allows you to enable the USB host mode to use USB peripherals shown in Figure 5.30, "USB Host Settings".

The "Enable USB port" option (shown in Figure 5.31, "Enable USB port") allows you to turn ON or turn OFF the USB port as needed.

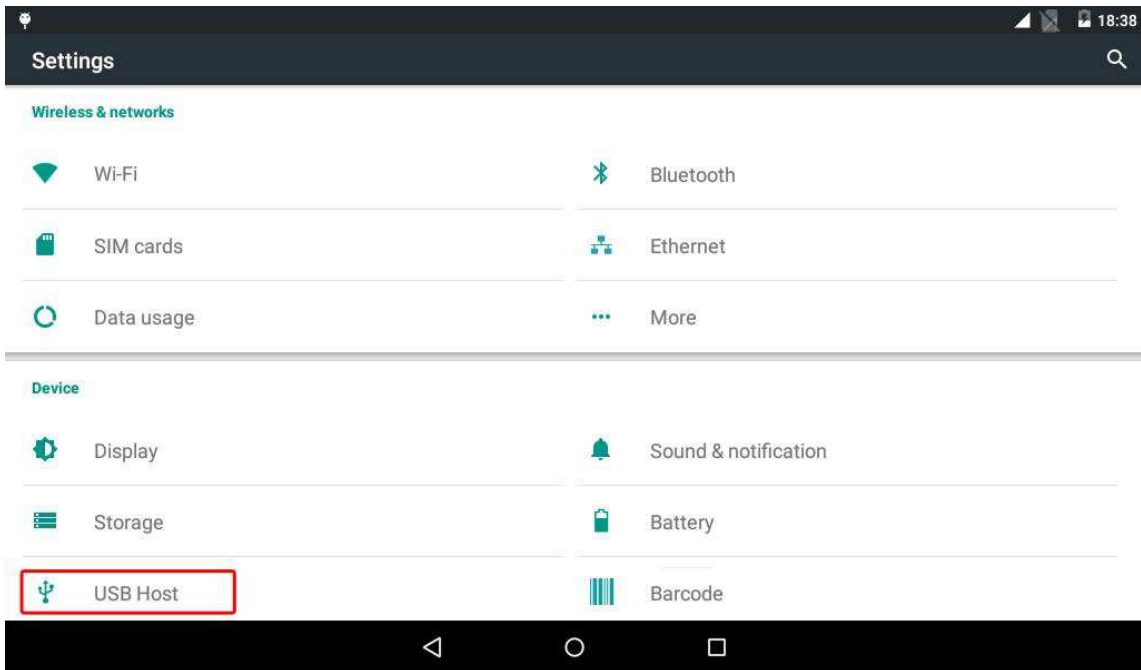

FIGURE 5.30. USB HOST SETTINGS

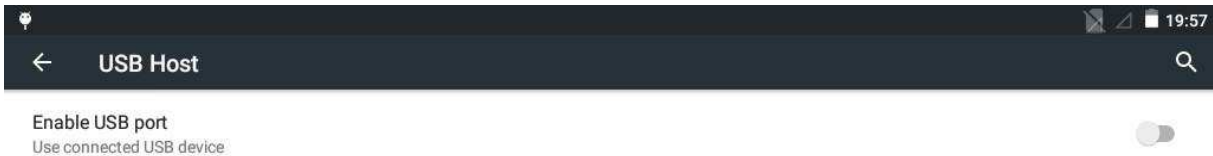

FIGURE 5.31. ENABLE USB PORT

5.2.6. Barcode

The barcode settings option allows you to enable/disable list of symbologies supported by barcode scanner. These may be individually enabled as shown in Figure 5.32, "Barcode Symbologies". All supported symbologies are enabled by default.

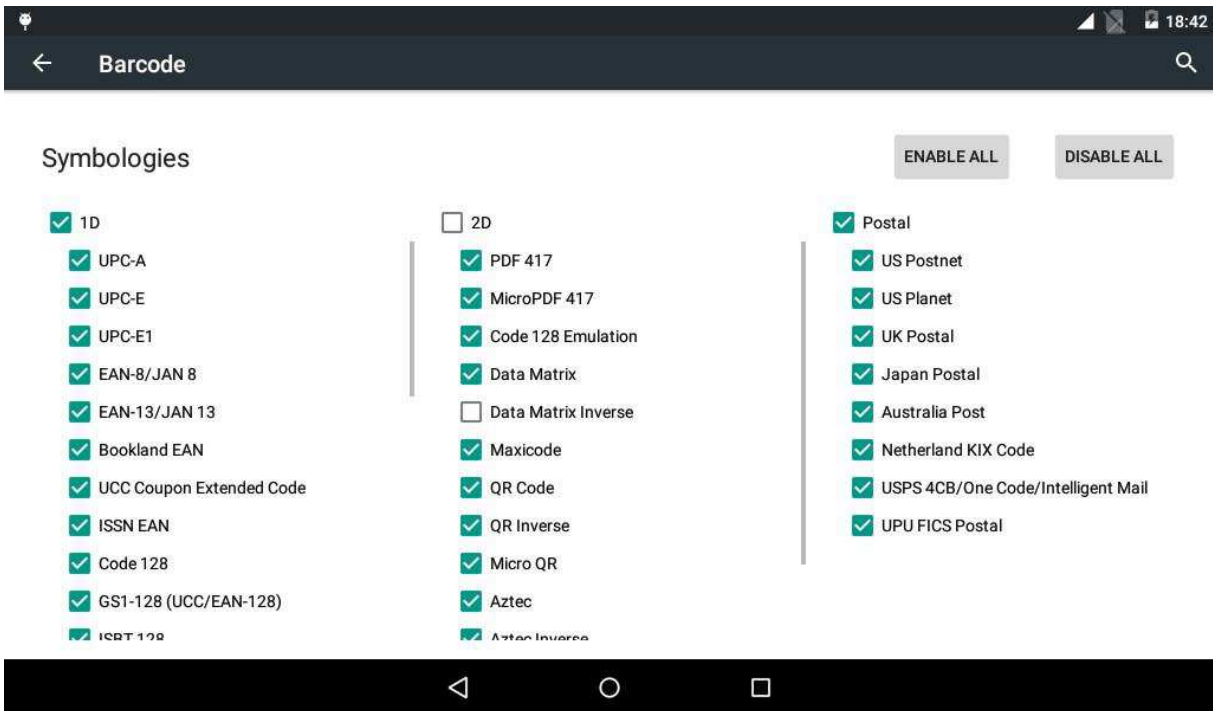

FIGURE 5.32. BARCODE SYMBOLOGIES

5.2.7. Apps

By using Apps settings you can view and manage applications. Here you can view all the applications installed in your tablet. To view category wise like Downloaded, On SD card, running scroll from right to left.

You can do following operations on a selected application as shown in Figure 5.33, "Application Information":

- Uninstall the application
- Stop the application forcefully
- Enable notifications
- Move application to SD card
- View permissions assigned for application

Using the menu on top-right corner you can: sort the application by size, reset app preferences and specify the install location (Internal storage or SD card) as shown in Figure 5.34, "Apps menu".

You can also see the RAM used by running application under "Running" applications list as shown in Figure 5.35, "Applications RAM usage".

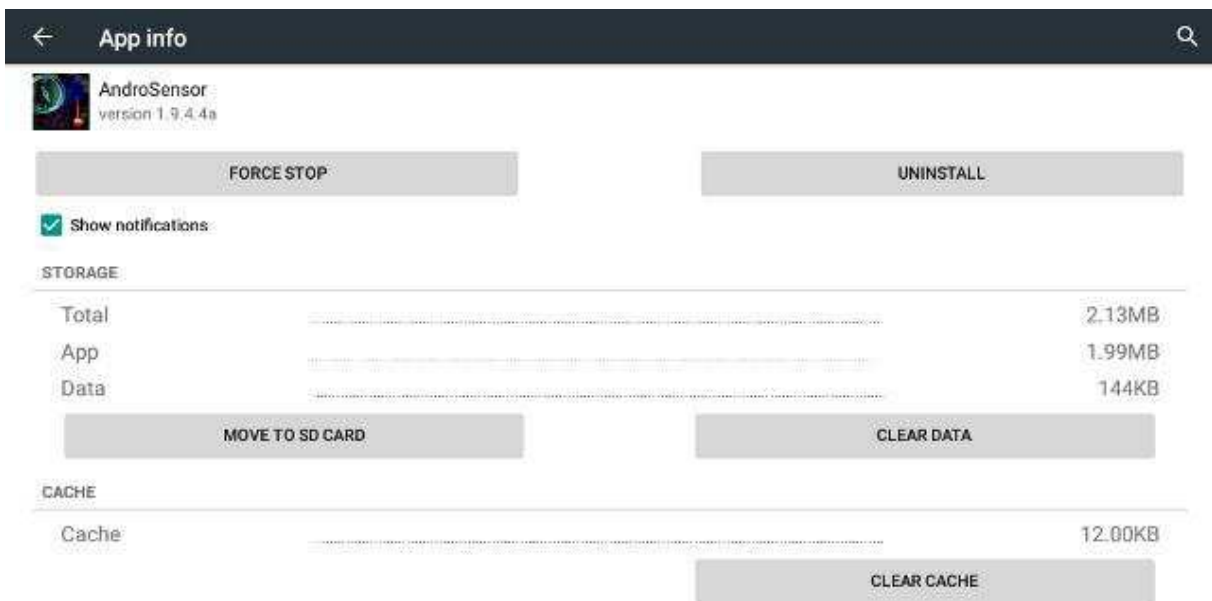

FIGURE 5.33. APPLICATION INFORMATION

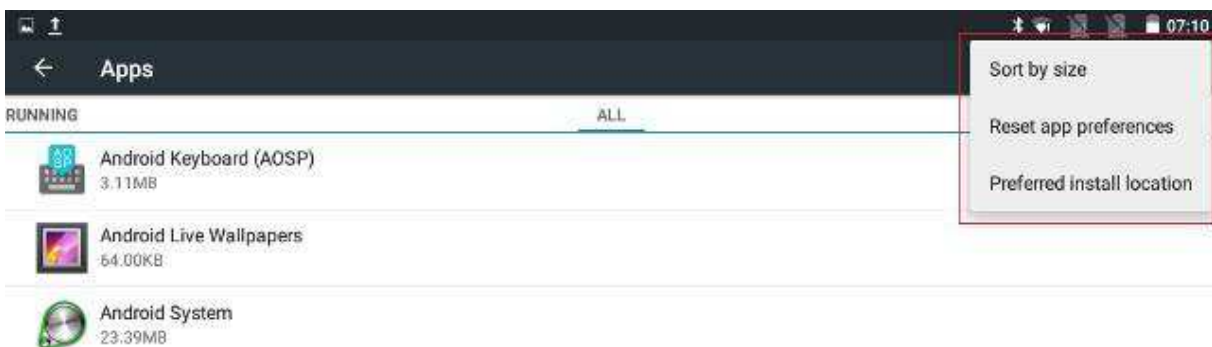

FIGURE 5.34. APPS MENU

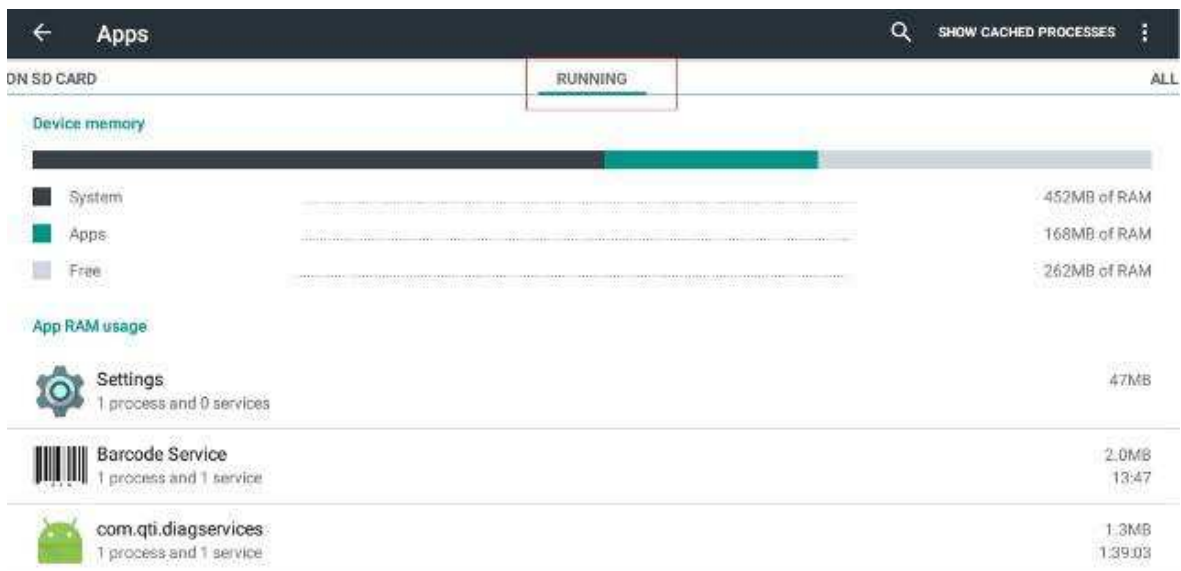

FIGURE 5.35. APPLICATIONS RAM USAGE

5.3. Personal

You can set language, location, security, backup for your tablet and add Google account details using options shown in Figure 5.36, “Personal Settings”.

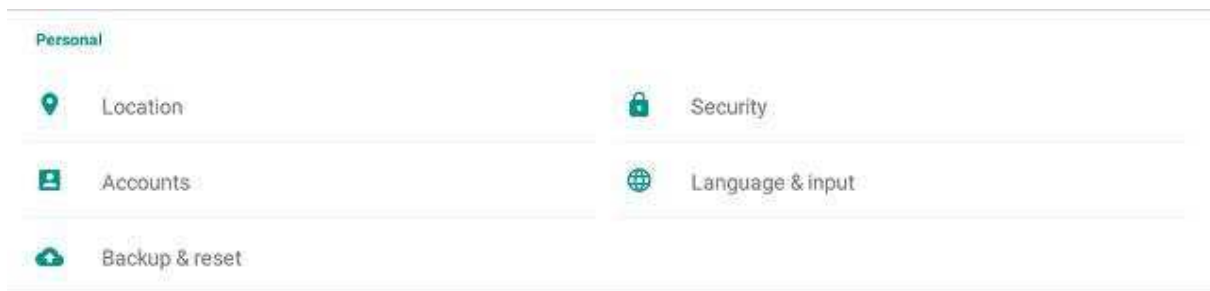

FIGURE 5.36. PERSONAL SETTINGS

5.3.1. Location

When Location is turned ON, you can select the following option in location mode as shown in Figure 5.37, “Location Mode”.

- High accuracy mode - uses GPS, Wi-Fi and cellular networks to determine the location.
- Battery saving mode - uses Wi-Fi and cellular networks to determine the location.
- Device only mode - uses GPS to determine your location.

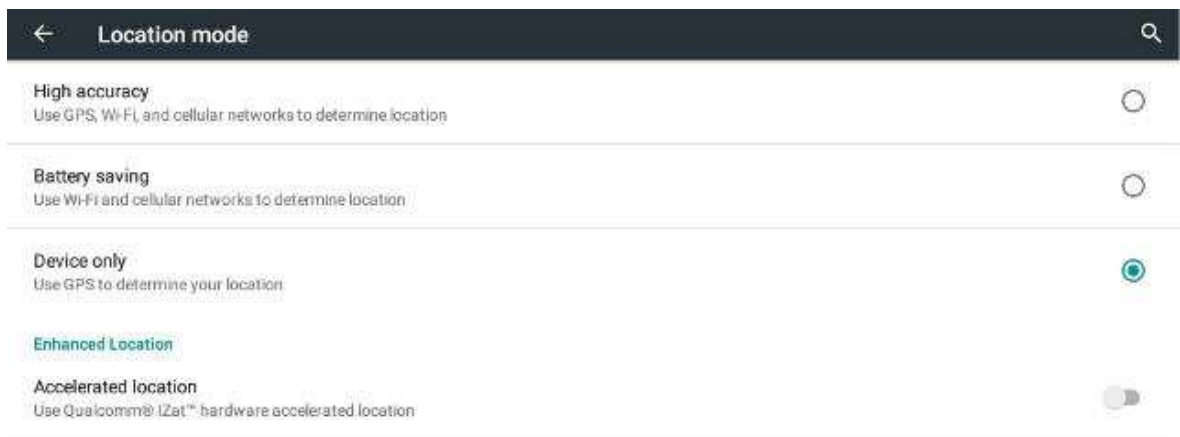

FIGURE 5.37. LOCATION MODE

To enable u-Blox GPS module:

- Turn Off Location.
- Touch "GPS Device" option and select "uBlox".
- Go to Location mode, then select the u-Blox platform model under Enhanced location as shown in Figure 5.38, "u-Blox Platform Model".

Selecting uBlox platform model gives uBlox module a hint about the mobility of the user.

Appropriate value can enable the module to generate better location.

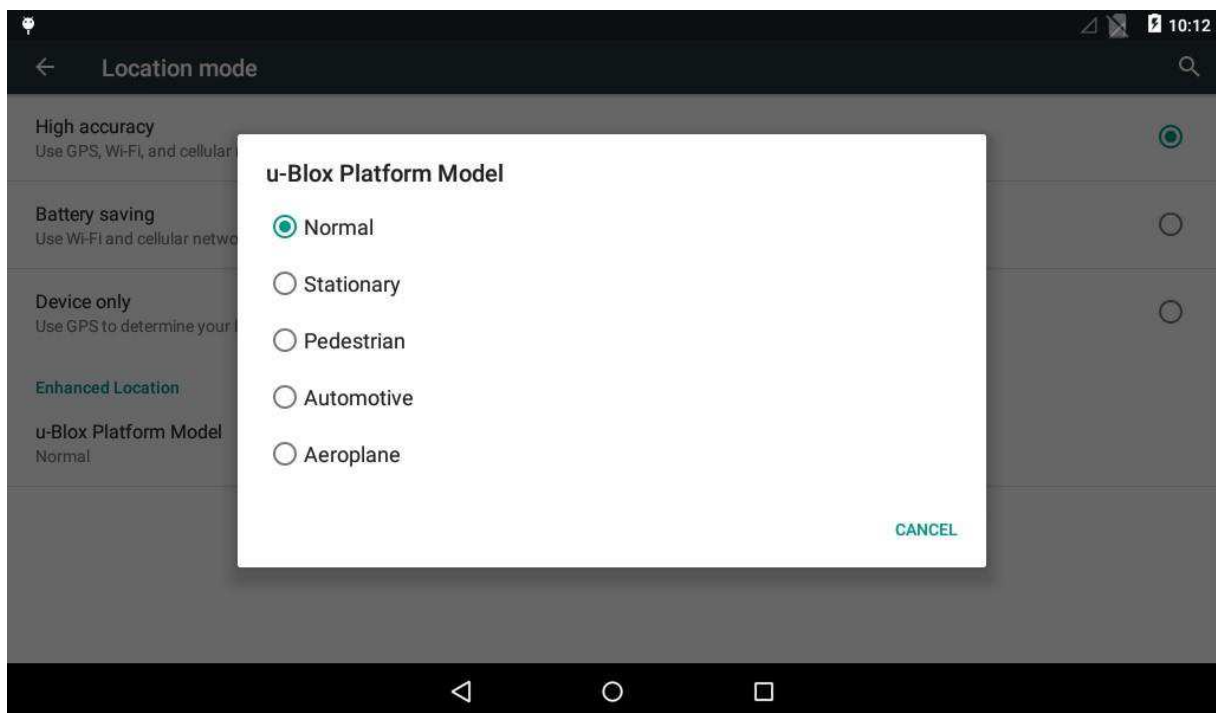

FIGURE 5.38. U-BLOX PLATFORM MODEL

5.3.2. Security

You can use below options to manage the security on your tablet:

- Screen Security - provides options to set security to touch screen.
 - Screen lock - you can set Swipe, Pattern, PIN or Password to unlock the screen.
 - Owner info - you can set a text to display on lock screen, by checking "Show owner info on lock screen" checkbox.
 - Smart Lock - you can set smart lock only when screen lock is set.
- Encryption - you can encrypt your accounts, settings, downloaded apps and their data, media and other files. After encrypting, you need to unlock the screen to decrypt the tablet every time you power it on.
- Passwords - You can make password visible.
- Device administration
 - Device administrators - you can view and deactivate device administrators.
 - Unknown sources - if enabled, it allows installation of applications from unknown sources.
- Credential storage - shows the storage type, trusted credentials and allows to install certificates from SD card
- Screen pinning - if turned ON, you can use screen pinning to keep the current screen in view until you unpin.

5.3.3. Accounts

To download applications from Google play store, you need to associate a google account with the tablet. Any added account remains effective till it is removed. To prevent data loss, you may sync the added account data automatically by checking "Auto-sync data" option in menu. Manual sync is also possible.

5.3.4. Language & input

The below options allows you to manage and control the language and input to your tablet.

- Language - select the language to use in your tablet from the available language list.
- Spell checker - if turned ON, you can select the language to be used and also you can enable the spell checker to use entries from contact list.
- Personal dictionary - you can maintain a personal dictionary by adding word using Add icon on top-right corner.
- Keyboard & input methods - allows you to select the keyboard type, and set preferences and text correction properties.
- Speech - allows you to select the voice input service and set text-to-speech conversion properties.
- Mouse/trackpad - provides a scroll bar to set the pointer speed by scrolling left to right.

5.3.5. Backup & Reset

- Back up my data - if you turned on, it back up app data, Wi-Fi passwords and other settings to google servers.
- Automatic restore - if turned on, when an app is reinstalled, it restores the backed up settings and data.

Factory data reset - if you use this option, it erase all data from your tablet's internal storage, including your Google account, system and app data and settings, downloaded apps and other user data.

5.4. System

System settings allows you to set system properties such as date & time, accessibility etc. as shown in Figure 5.39, “System Settings”.

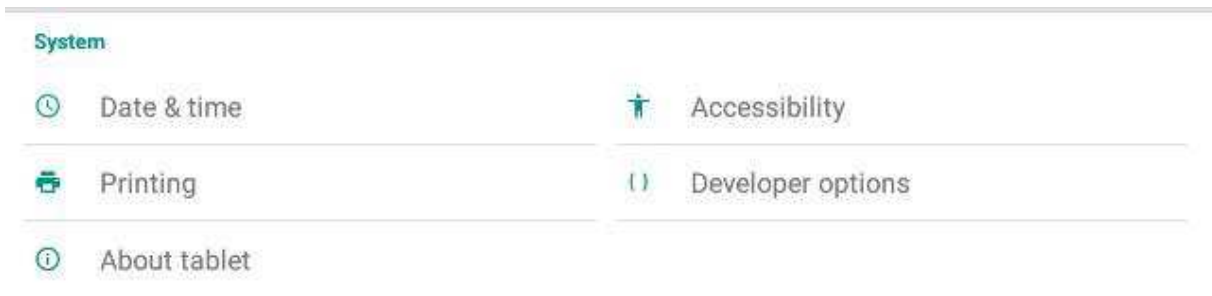

FIGURE 5.39. SYSTEM SETTINGS

5.4.1. Date & time

You can do following operations as shown in Figure 5.40, “Date & time Settings”:

- Set date and time manually
- Select the time zone
- Enable 24-hour time format
- Enable automatic date & time update
- Enable automatic time zone selection

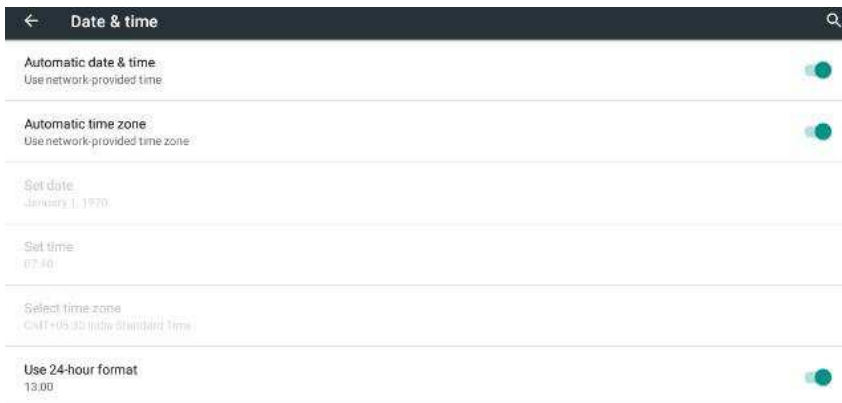

FIGURE 5.40. DATE & TIME SETTINGS

5.4.2. Printing

You can install the printer service to access it.

5.4.3. Accessibility

The accessibility settings allows you to do following operations:

- Configure the hot keys
- Set captions
- Enable magnification gesture
- Set large text
- Set High contrast text
- Enable power button ends call
- Enable Auto-rotate screen
- Enable speak passwords
- Text to speech conversion
- Set delay for touch & hold
- Invert the color

5.4.4. About tablet

You can see the following information about your tablet in this option as shown in Figure 5.41, “About tablet”.

- System updates - shows when last updated and you can check for the updates
- Status - shows battery and network related information, such as charging status, remaining battery, IP address, Wi-Fi MAC address, Bluetooth address, Unit serial number, Serial number, Up time.
- Legal information - shows open source licenses, Google legal information and wallpapers providers information
- Model number
- Android version
- Kernel version
- Build number
- Software Update Level - this identifies the version of software installed on your tablet.



FIGURE 5.41. ABOUT TABLET

5.5. User Configurable Hotkeys

The Algiz RT7 includes four user configurable hotkeys. Each hotkey can be configured for the following functions:

- Android Back Key
- Android Home Key
- Scan barcode (using the barcode scanner)
- Launch an Application
- Deactivated

Hotkey configurations is access from the Settings application, under "Accessibility". Each of the four keys can be configured independently, as shown in Figure 5.42, "Hotkey Configuration"

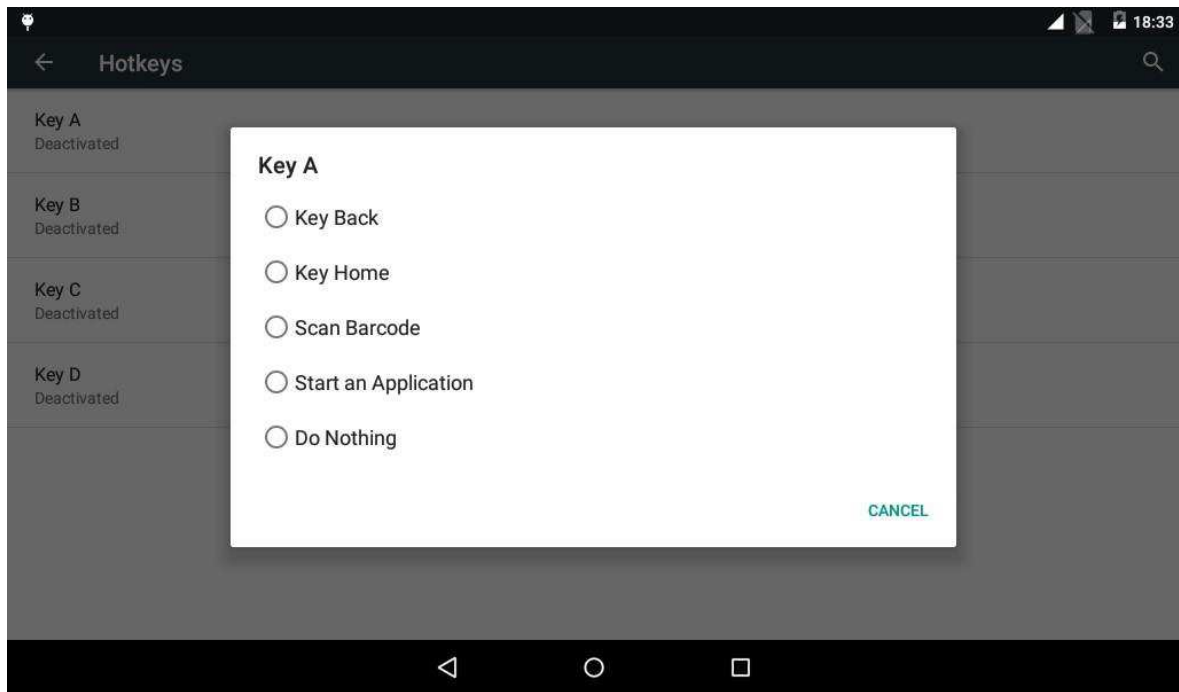

FIGURE 5.42. HOTKEY CONFIGURATION

If you select to launch an application, then another dialog will be presented, where you will need to select the application to launch. Once selected, the change is effective immediately.

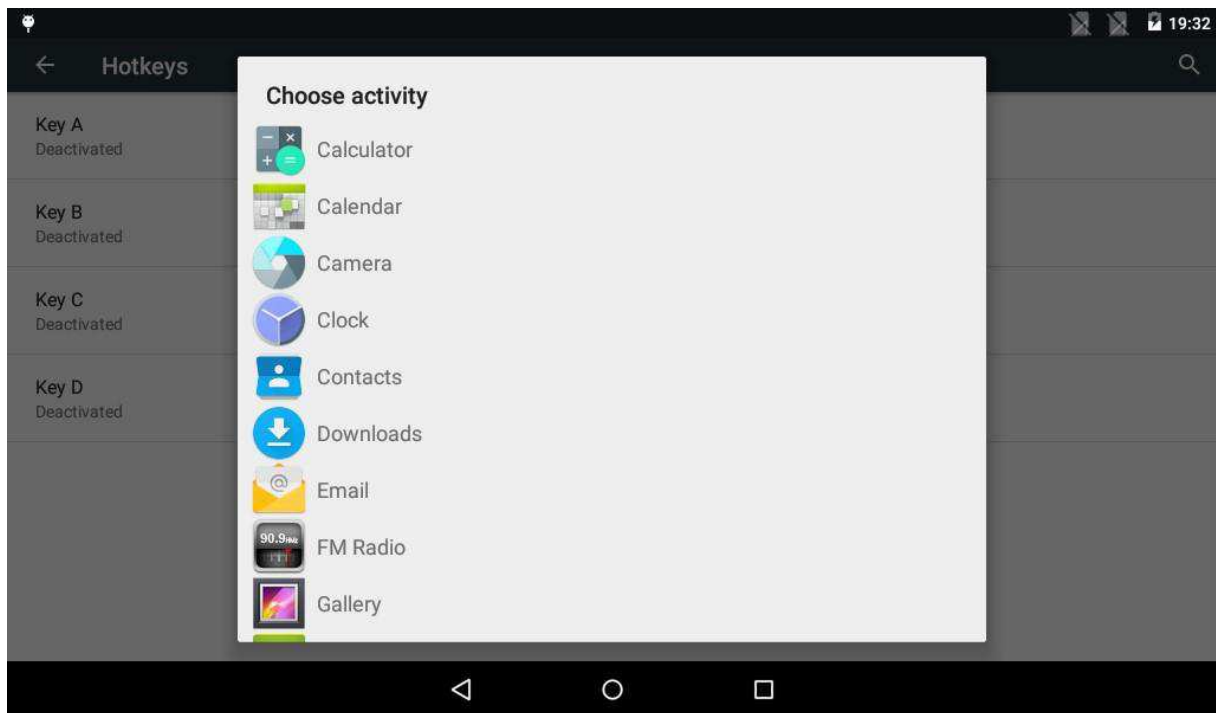

FIGURE 5.43. CHOOSE THE APPLICATION TO LAUNCH

5.6. Applications

Your tablet is pre-installed with several useful applications:

- Calculator for simple calculations on the go.
- Clock to keep a tab on time and setup alarms.
- Calendar to maintain your calendar, and keep it synced online.
- Camera to record up-to 8 megapixel picture, or capture 1080p videos.
- Email for connecting to your email provided.
- Gmail for email via your google account.
- File Explorer to navigate around the storage on the device.
- Keep for taking notes.
- Maps for navigation.
- Phone for making phone calls.
- Hangouts for messaging.
- Play Store to install apps from the Google Play Store
- YouTube for movies
- FM Radio to listen to radio. The device uses a headset connected to the 3.5mm audio socket as the antenna, so that needs to be plugged in to use the FM radio.
- Sheets, Slides, and Docs allow you to edit spreadsheets, presentations and documents, respectively

6. STORAGE

Storage is a place where your data, applications, media files etc are stored. This tablet comes with an internal storage and supports external storage through SD card and USB drive.

6.1. Internal Storage

This tablet comes with 16 GB internal storage capacity, in which the operating system and built-in applications are stored.

When you install any application by default it stores in internal storage.

If you go to Settings → Device → Storage → Internal storage it shows the details such as total space allowed, available space and space used by different applications as shown in Figure 5.26, "Internal storage Settings".

To view the data stored under internal storage use the File Explorer app.

When you connect the tablet to computer, you can see a drive named "Internal storage".

If you click the drive, it displays different folders contains the categorized data.

6.2. SD card

This tablet supports SD card up to 2TB.

To use SD card as secondary storage, insert SD card into tablet's Micro SDXC slot as shown in Section 3.2, "SD Card". Once SD card mounted, you can view the files in SD card using File Explorer application.

When you connect the tablet to computer, you can see a drive named "SD card". If you click the drive, it displays different folders contains the categorized data.

You can remove the content in SD card and unmount by using options in Storage Settings shown in Figure 5.27, "SD card storage Settings".

6.3. USB Storage

To use USB storage connect the device to tablet as shown in Figure 6.1, "USB storage", then enable USB port as mentioned in Figure 12.1, "USB Host port"

If a USB storage device is connected, then you can see the available space, erase all data and unmount it by using options in USB storage settings shown in Figure 5.28, "USB storage Settings".

Such devices must be formatted with a single FAT partition; NTFS partitions are not supported.

Only one USB storage device may be used at any time. To prevent data loss, it is always advisable to unmount the USB storage using "Unmount USB storage" option in Settings, prior to disconnecting it.



FIGURE 6.1. USB STORAGE

To view the files stored in connected USB device, use the File Explorer app.

7. INPUT

7.1. Touch Screen

The touch-screen features an anti-glare coating. Five point touch is supported.

Common gestures like pinch-zoom can be used.

7.2. USB Input devices

You can use USB keyboard or USB mouse as USB input device.

To use USB Input device follow below steps as mentioned in Chapter 12, USB.

1. Connect the device to the tablet through the USB host port.
2. Select "USB Host" option in Settings.
3. Turn ON the "Enable USB port" option.

Now, the connected input device is ready to use. If you connected a keyboard, then the on-screen soft keyboard will get disabled automatically.

If you connected a mouse, then you will see a pointer on the screen. Moving the mouse will move the pointer. Most applications treat the left click as a touch at the pointer location.

When you do not want to continue using connected input device, disconnect it from the tablet, and turn off the USB host mode.

7.3. Bluetooth Input devices

Bluetooth input devices (keyboards and mice) can be used with the tablet. Pair them to the tablet, as you would do for any Bluetooth device. The device will then be ready to use.

8. COMMUNICATION

8.1. Ethernet

10/100 Ethernet port on the device allows you to connect to Ethernet. The Ethernet port is located on the right side of the device, in the port cluster shown in Figure 8.1, “Ethernet Port”.

Insert the Ethernet cable as shown in Figure 8.2, “Ethernet Cable Insertion”. To enable Ethernet and set static IP see Section 5.1.4, “Ethernet”.

It is recommended to use Ethernet cables with length less than 3 meters.

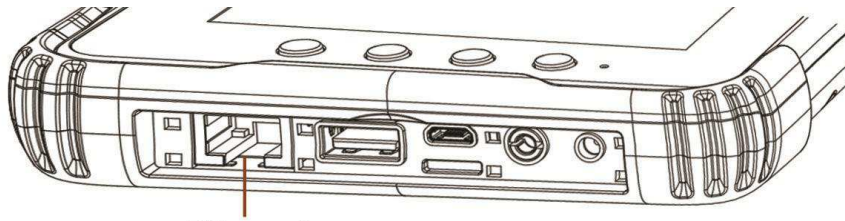

Ethernet

FIGURE 8.1. ETHERNET PORT

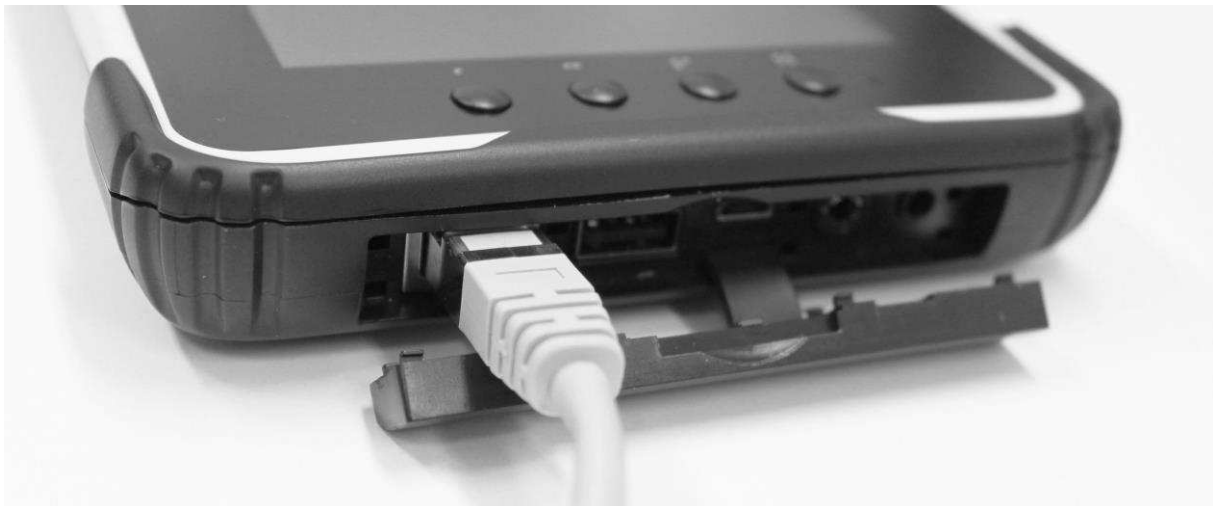

FIGURE 8.2. ETHERNET CABLE INSERTION

Once tablet is connected to Ethernet cable, the connection status is shown on the status bar:

- A white Ethernet icon means that the tablet is connected to the Ethernet network.
- A green Ethernet icon means that the Ethernet network link is UP. The device is attempting to connect to the Ethernet network at this time.
- A red Ethernet icon means that Ethernet is enabled, but the Ethernet network link is down. To achieve a connection, you need to ensure that both ends of the Ethernet cable are properly connected to the respective ports.

8.2. Wireless Communication

8.2.1. Bluetooth

This tablet supports Bluetooth communication 10m and 100m. To do Bluetooth communication with other device, you need to pair it with this tablet (see Section 5.1.2, “Bluetooth”).

Bluetooth file transfer

To transfer a file to paired device using Bluetooth:

1. Turn ON Bluetooth.
2. Select the file to transfer.
3. Touch the Bluetooth icon on top-right corner (shown in Figure 8.4, “Bluetooth Icon in File transfer”).
4. Select the device to transfer (shown in Figure 8.5, “Device list to transfer”).

Once the connection is successful, it starts transferring the file. You can see the file sending notification on screen. If the file transfer is successful, you can see the file listed under outbound transfers (shown in Figure 8.3, “Bluetooth Outbound transfers”) by touching the notification.

When there is an incoming file from paired Bluetooth device, the tablet pops up a message as shown in Figure 8.6, “Accept File request”, which shows the details such as sending device name, file name and size. You can either accept or decline the incoming file.

Touch "ACCEPT" on Accept incoming file message, to receive the file.

The received file will be listed under inbound transfers (shown in Figure 8.7, “Bluetooth Inbound transfers”).

Received file stores in internal storage Bluetooth folder.

You can use File Explorer application to see all files received from Bluetooth devices as shown in Figure 8.8, “Bluetooth files”.



FIGURE 8.3. BLUETOOTH OUTBOUND TRANSFERS

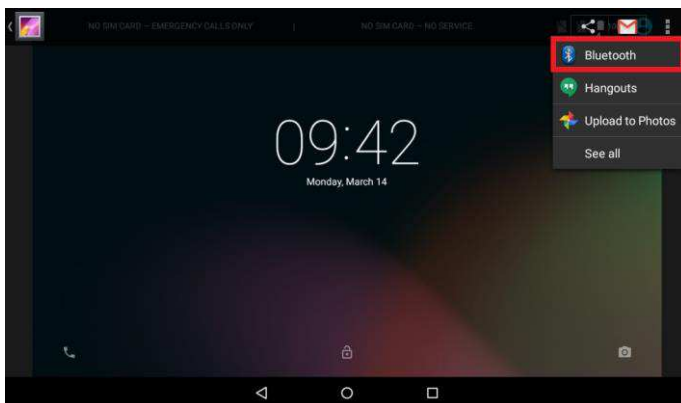

FIGURE 8.4. BLUETOOTH ICON IN FILE TRANSFER



FIGURE 8.5. DEVICE LIST TO TRANSFER

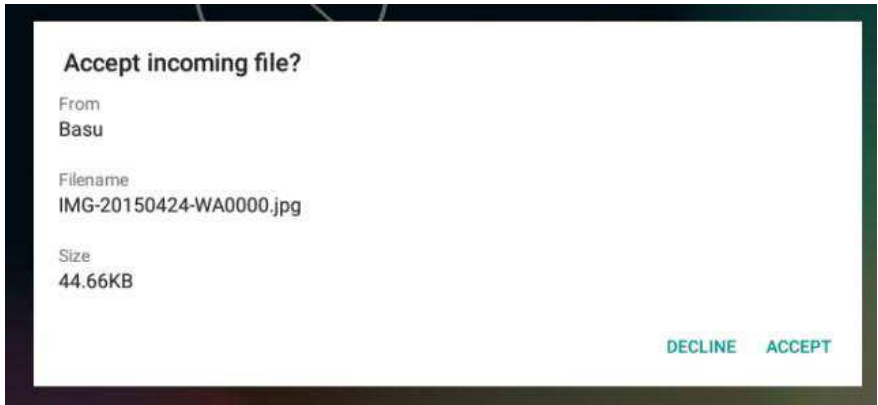

FIGURE 8.6. ACCEPT FILE REQUEST

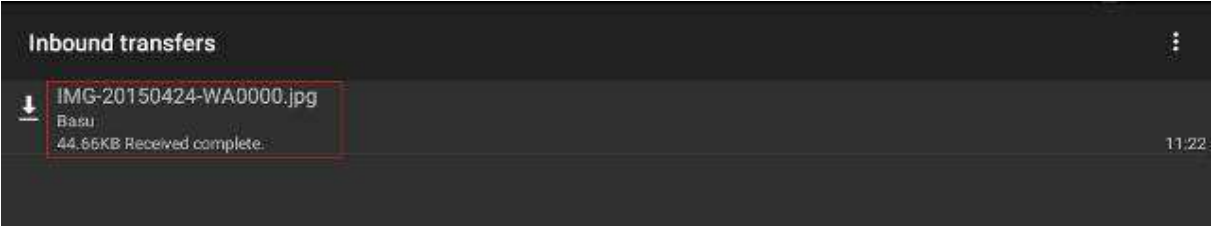

FIGURE 8.7. BLUETOOTH INBOUND TRANSFERS

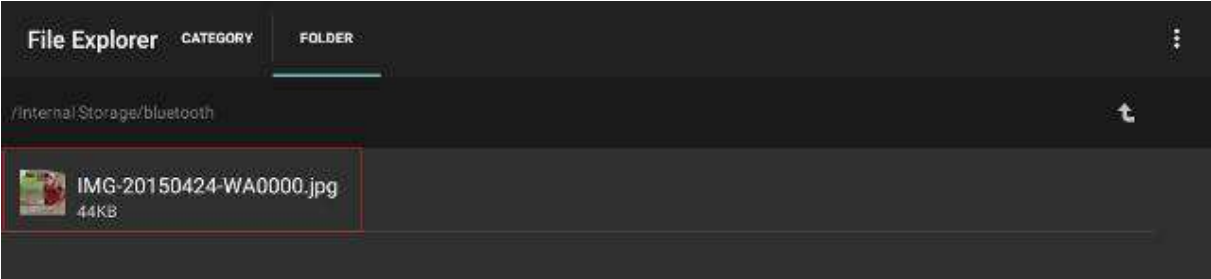

FIGURE 8.8. BLUETOOTH FILES

8.2.2. Wi-Fi

This tablet supports Wi-Fi 802.11 b/g/n. To use any available Wi-Fi network, setup Wi-Fi as shown in Section 5.1.1, “Wi-Fi”.

Sometimes, you may want to know the MAC address of the Wi-Fi interface. This is available from Settings → About Tablet → Status → Wi-Fi MAC address

9. LOCATION

9.1. Internal GPS

The device uses the Qualcomm iZat GPS by default. The currently enabled GPS can be checked, using the "GPS Device" option under Settings | Location. Figure 9.1, "Choose GPS Device" shows the currently enabled GPS module.

9.2. u-Blox GPS Module

The u-Blox GPS module can be enabled when needed, as mentioned in Section 5.3.1, "Location".

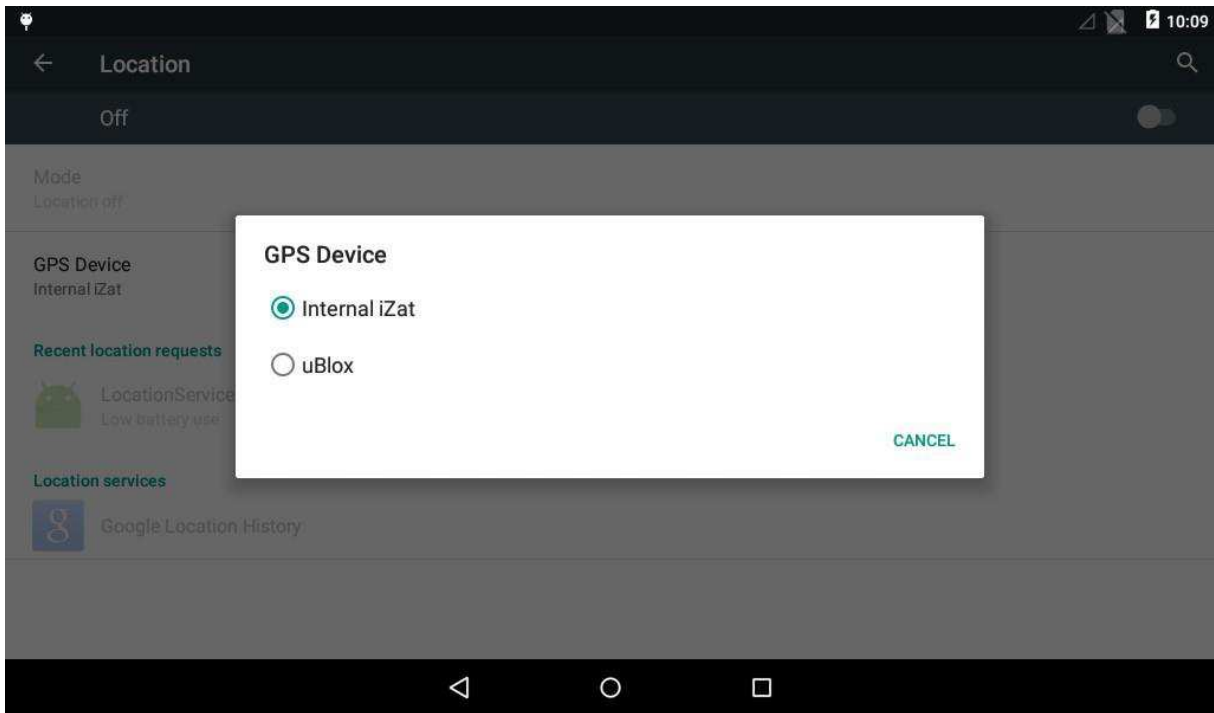

FIGURE 9.1. CHOOSE GPS DEV

10. RFID

10.1. NFC

You can use NFC (Near Field Communication) to exchange data when your tablet touches another device. Enable NFC option in Wireless & networks settings as shown in Figure 10.2, “Enabling NFC”.

To exchange data using NFC:

- Turn ON NFC and Android beam on both devices.
- Go to screen which contains information to exchange.
- Move your tablet towards back of other device.
- Once a connection is established, you will hear a sound.
- Touch screen to transfer the data.

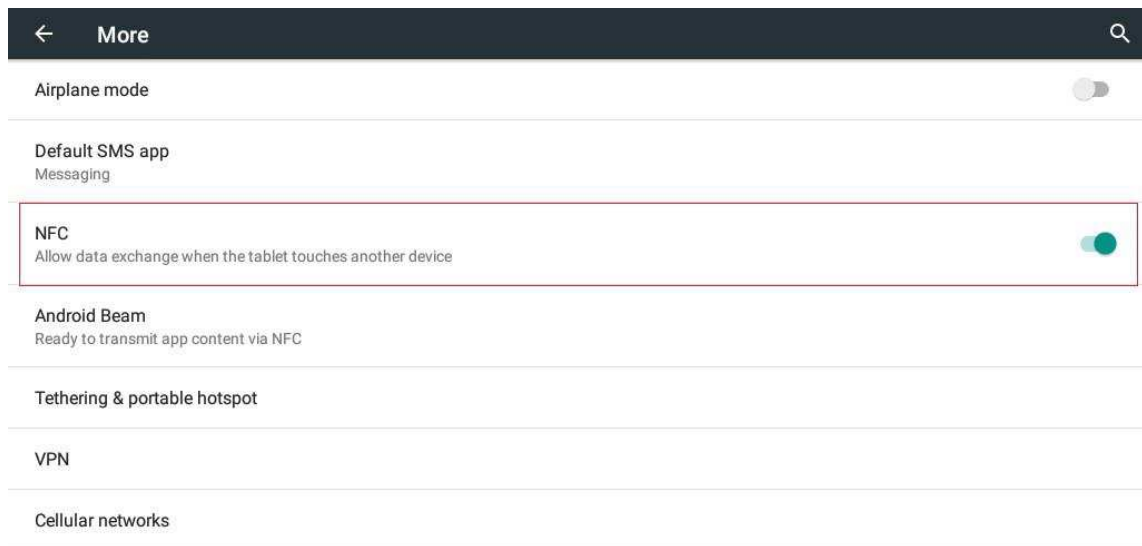

FIGURE 10.1. ENABLING NFC

10.2. Arcontia RFID Module (eTicket version only)

The eTicket version of Algiz RT7 is equipped with an Arcontia RFID reader. This can be tested using the included "RFID test" application, as shown in Figure 10.2. "RFID Test Application".

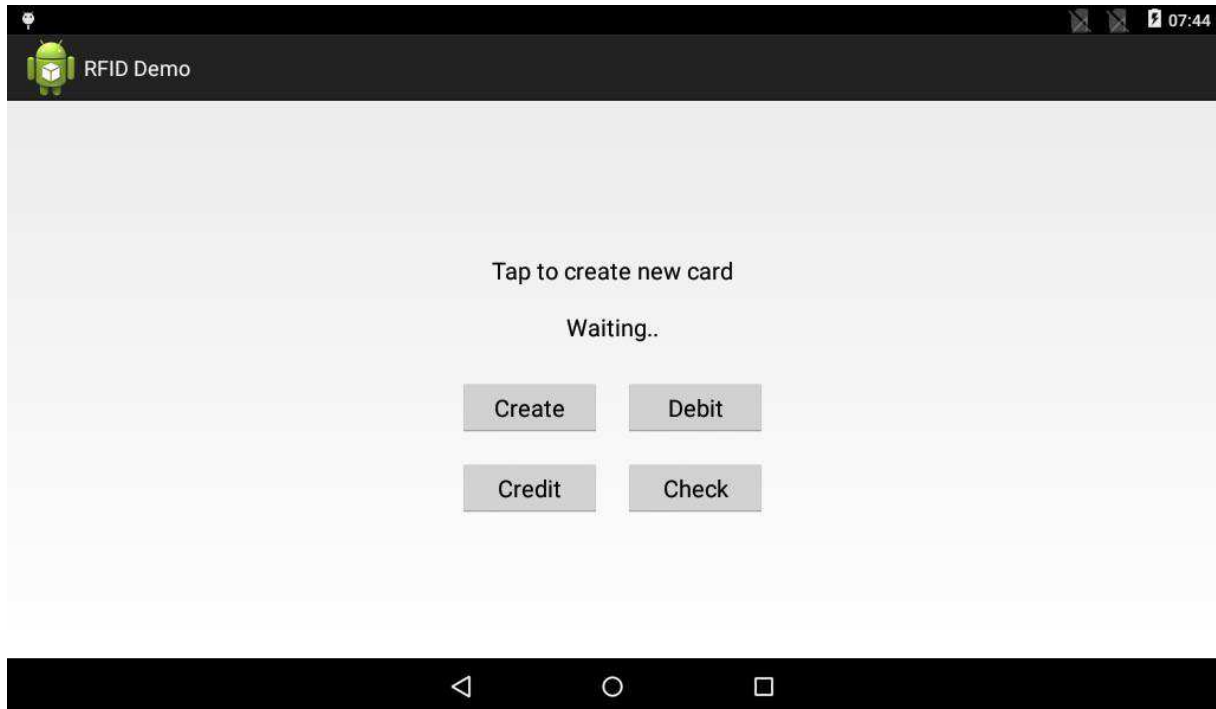

FIGURE 10.2. RFID TEST APPLICATION

11. BARCODE SCANNER

If any of the hotkeys is mapped to scan a barcode, then the barcode scanner can be activated on a touch of that hotkey.

The red LED aimer turns ON shortly after the hotkey is pressed. The user needs to keep the hotkey pressed for the duration of the scanning. The scanning remains active till a barcode is found, or the user releases the hotkey, or ten seconds have elapsed (i.e. timeout), whichever is earlier. Scanning is kept active for a minimum of two seconds, even if the user releases the hotkey in that time. This allows quick scanning of barcodes by a quick push of the hotkey.

If the scan is successful, then the scanned barcode is sent as text to the running application. To properly capture the barcode, it is recommended that the user selects a text control prior to scanning a barcode.

The barcode scanner supports a variety of symbologies: 1D, 2D and Postal codes. User may restrict the barcode symbologies that are decoded, from Section 5.2.6, "Barcode".

A test application "Barcode Decoder" for the barcode scanner is also installed on the device. This directly supports decoding barcodes. The symbologies to decode is configurable via Settings provided in the application itself. Note that the settings of this application are independent of the system defined settings.

12. USB

A dedicated A-type USB host port is available on the device. The following types of USB devices may be connected to it

- USB storage devices like disk drives & pen drives.
- USB keyboard or USB mouse.

The user need to connect the USB peripherals through USB host port in right side panel shown in Figure 12.1, “USB Host port”.

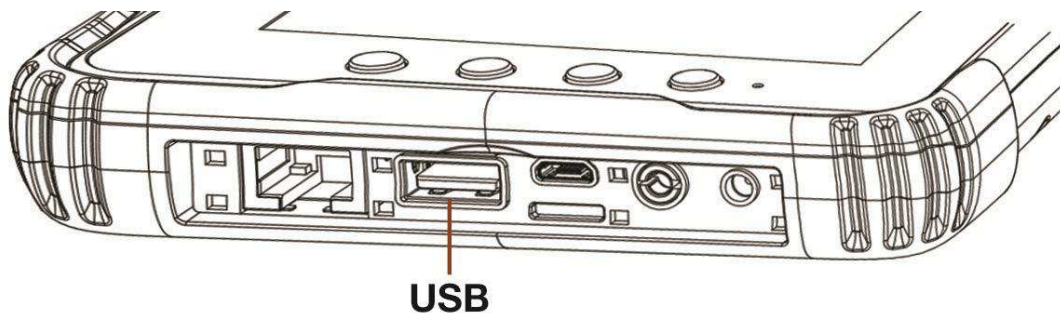

FIGURE 12.1. USB HOST PORT

Once USB peripheral is connected, the user needs to enable the USB host mode to use USB peripherals as mentioned in Section 5.2.5, “USB Host”.

While using the USB device you cannot turn OFF USB mode. If you try to turn OFF device will pop up a message as shown in Figure 12.2, “USB turn OFF message”.

Cannot turn off USB host mode

A USB storage device is in use. Turning off USB host now may cause data loss. Please unmount the USB storage and retry.

OK

FIGURE 12.2. USB TURN OFF MESSAGE

It is also possible to connect a second USB device to the OTG port using a host type cable. When this is done, the connected device will get power immediately. However, it will not be usable unless the USB host mode is enabled from settings.

When Ethernet is enabled, then the connect USB devices will get power. However, the USB devices will not work unless the USB host mode is enable

handheld