

# ALGIZ RT7

## QUICK START GUIDE



**handheld**

# 1 WHAT'S IN THE BOX

The pictures shown below may differ from the actual products. To purchase additional or optional products, contact our customer centre.

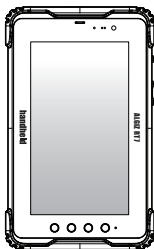

Algiz RT7 Main Body

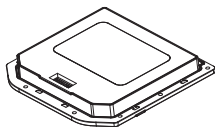

Battery Pack



Battery Screws

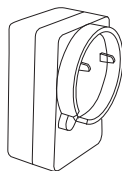

Charging Adaptor



3.5mm Barrel  
Connector Cable



Micro USB  
Cable



Headset

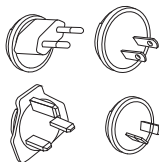

Converter Plugs

## 2 YOUR ALGIZ RT7

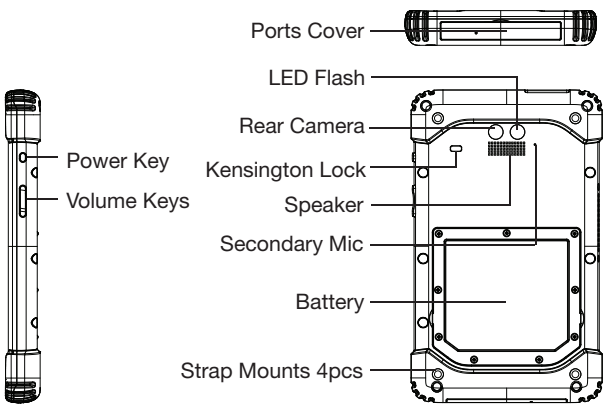
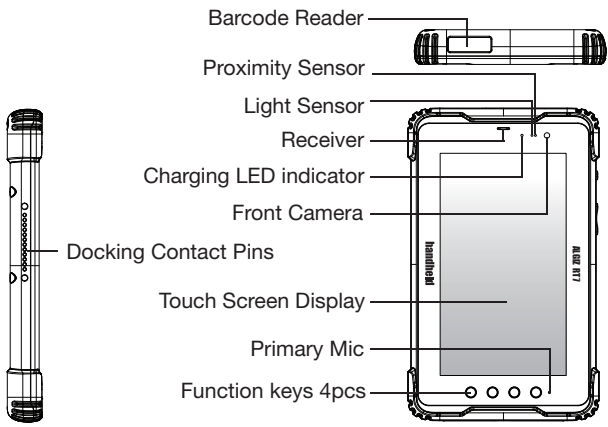

### 3 INSERTING/EXTRACTING SIM/MICRO SD CARD

This is how you insert and remove the SIM/ micro SD.

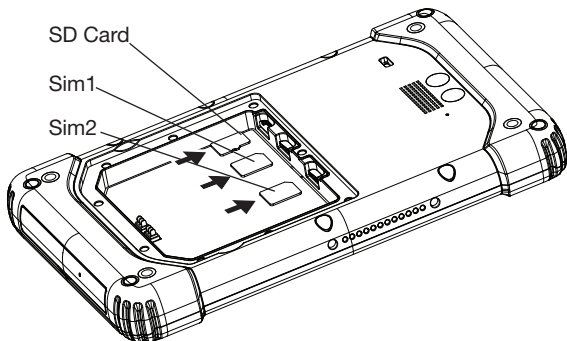

## 4

**INSERT/REMOVE BATTERY****To insert the battery**

1. Place the battery pack on the back as shown.
2. Using the battery screws (M2 X 5mm) fasten them in position.

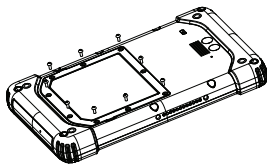
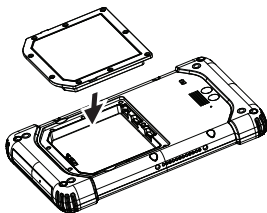
**To remove the battery**

1. Power off the device.
2. Open the battery cover by unfastening the screws.
3. Remove the battery pack.

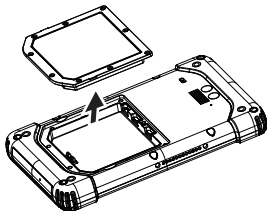
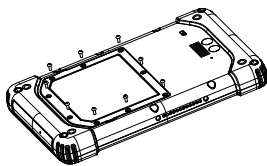

## 5 POWERING ON/OFF

Press the [Power] button on the right side of the device to turn the Algiz RT7 unit on/off.

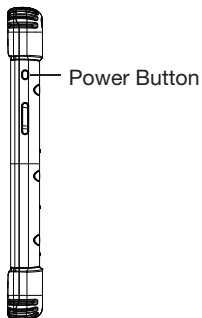

## 6 BATTERY CHARGING

Charge the unit for 3 hours before using the device for the first time.

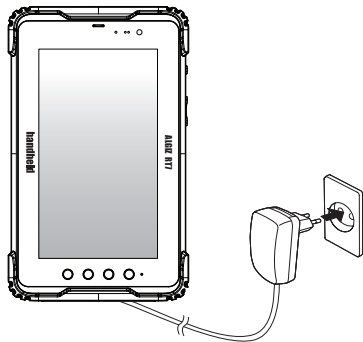

7

## I/O COMPARTMENT LAYOUT

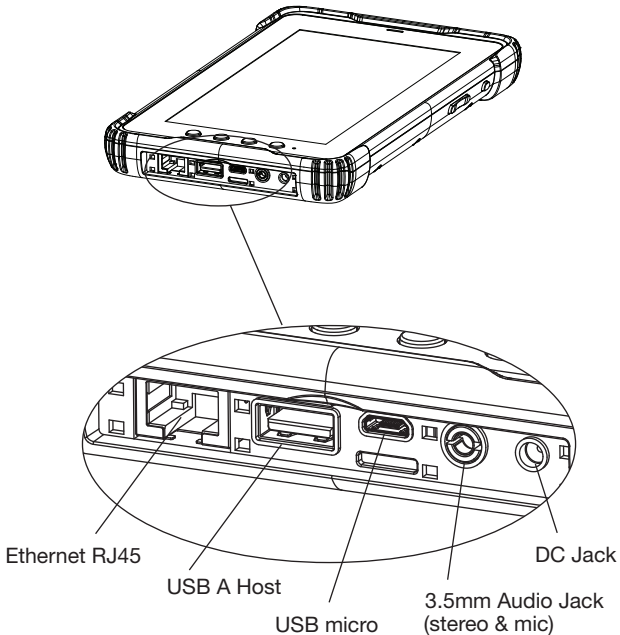

Please go to [www.handheldgroup.com/knowledgebase](http://www.handheldgroup.com/knowledgebase) to download more information.

*Algiz RT7 is in compliance with the essential requirements and other relevant provisions of Directive 1999/5/EC. The declaration of conformity may be consulted at [www.handheldgroup.com/algiz-rt7/#tab=manuals](http://www.handheldgroup.com/algiz-rt7/#tab=manuals)*

Android and Google are trademarks of Google Inc. The Android robot is reproduced or modified from work created and shared by Google and used according to terms described in the Creative Commons 3.0 Attribution License.

**Version 1.1**

**handheld**

**[www.handheldgroup.com](http://www.handheldgroup.com)**